



CATÁLOGO
CATALOGUE

LOS INVISIBLES THE INVISIBLES

**CLIMATIZACIÓN
SIN UNIDAD EXTERNA**

**AIR CONDITIONERS
WITHOUT OUTDOOR UNIT**

**ED. 01/2026
ES | ENG**



ELFO

Motocondensador oculto aire-aire Invisible air-to-air condensing unit

6

MONOSPLIT

8

MULTISPLIT

10

ACCESORIOS OPCIONALES PARA ELFO | OPTIONAL ACCESSORIES FOR ELFO

12

A PROPÓSITO DE ELFO | ABOUT ELFO

13

ELFO VRF

16

A PROPÓSITO DE ELFO VRF | ABOUT ELFO VRF

18

Unidades interiores para ELFO VRF Indoor units for ELFO VRF

20

SPLIT DE PARED | WALL MOUNTED

20

TECHO/SUELO | CEILING/FLOOR

20

CONDUCTO DE BAJA PRESIÓN ESTÁTICA | LOW STATIC PRESSURE DUCTED UNIT

21

CONDUCTO DE PRESIÓN ESTÁTICA MEDIA | MEDIUM STATIC PRESSURE DUCTED UNIT

21

CONDUCTO DE ALTA PRESIÓN ESTÁTICA | HIGH STATIC PRESSURE DUCTED UNIT

22

CASSETTE DE 4 VÍAS | 4-WAY CASSETTE

22

CASSETTE ROUND-FLOW | ROUND FLOW CASSETTE

23

COMBINACIONES SOPORTADAS | SUPPORTED COMBINATIONS

23

IDRA

Motocondensador oculto agua-aire Invisible water-to-air condensing unit

24

NEXT MONOSPLIT DC INVERTER

26

NEXT MULTISPLIT DC INVERTER

28

ECO MONOSPLIT (ENERGY SAVING)

30

ECO MULTISPLIT (ENERGY SAVING)

32

RING MONOSPLIT

34

RING MULTISPLIT

36

A PROPÓSITO DE IDRA RING | ABOUT IDRA RING

38

CONSEJOS DE INSTALACIÓN | INSTALLATION TIPS

42

ACCESORIOS IDRA | ACCESSORIES FOR IDRA

43

R3

Sistema inteligente de recuperación del agua Intelligent water recovery system

44

Unidades interiores para ELFO y IDRA Indoor units for ELFO and IDRA	46
IMAGINE (SPLIT DE PARED) WALL MOUNTED	46
SKIV (SPLIT DE PARED) WALL MOUNTED	48
DUCTO HORIZONTAL INVERTER INVERTER HORIZONTAL DUCT	48
DUCTO HORIZONTAL/VERTICAL INVERTER INVERTER HORIZONTAL/VERTICAL DUCT	49
CONSOLA CONSOLLE	49
CASSETTE COMPACTA CASSETTE COMPACT	50
CASSETTE CASSETTE	50
COMBINACIONES SOPORTADAS SUPPORTED COMBINATIONS	51
ACCESORIOS PARA UNIDADES INTERIORES INDOOR UNITS ACCESSORIES	52
ACCESORIOS PARA UNIDAD MOTOCONDENSADORA CONDENSING UNITS ACCESSORIES	53
ACCESORIOS PARA UNIDADES CANALIZADAS DUCT UNITS ACCESSORIES	54
A PROPÓSITO DE LA ZONIFICACIÓN ABOUT ZONING	61
KIT OPAL OPAL KIT	62
KIT AIRZONE AIRZONE KIT	64
KIT MADEL MADEL KIT	66
PICCOLO	
Unidad motocondensadora agua-aire compacta Compact water-to-air condensing unit	68
CAIO	
Monobloque agua-aire canalizable Ducted water-to-air monobloc unit	70
KIT PARA CANALIZACIÓN CAIO DUCTING KIT	74
IQ	
Monobloque aire-aire de doble conducto Double duct air-air monobloc unit	76
iSTYLE	
Monobloque aire-aire de doble conducto super slim Super-slim double duct air-to-air monobloc unit	78
MOKA	
Monobloque aire-aire de doble conducto con Wi-Fi Double duct air-to-air monobloc unit with Wi-Fi	80
ATHENA-C	
Bomba de calor aire-agua monobloque interior Air-to-water heat pump fully internal	82
A PROPÓSITO DE ATHENA-C ABOUT ATHENA-C	84
VAIA	
Bomba de calor aire-agua monobloque interior compacta Compact air-to-water heat pump fully internal	86
A PROPÓSITO DE VAIA ABOUT VAIA	88
NUESTRA GARANTÍA OUR WARRANTY	90

CLIMATIZACIÓN AIR CONDITIONING

LOS INVISIBLES THE INVISIBLES

 LOS SISTEMAS DE CLIMATIZACIÓN CON UNIDAD CONDENSADORA INVISIBLE REPRESENTAN LA SOLUCIÓN IDEAL PARA GARANTIZAR EL CONFORT CLIMÁTICO, PRESERVANDO AL MISMO TIEMPO EL DECORO ARQUITECTÓNICO.

Gracias a la instalación de la unidad condensadora dentro de la vivienda, la estética de las fachadas exteriores permanece inalterada, con un impacto visual mínimo o nulo según las soluciones adoptadas. Esta tecnología innovadora asegura un alto rendimiento en términos de eficiencia energética y silencio, ofreciendo un confort climático excelente con pleno respeto a la integridad arquitectónica.

 AIR CONDITIONING SYSTEMS WITH CONCEALED CONDENSING UNITS ARE THE IDEAL SOLUTION FOR ENSURING CLIMATE COMFORT WHILE PRESERVING ARCHITECTURAL AESTHETICS.

Thanks to the installation of the condensing unit inside the home, the aesthetics of the exterior façades remain unchanged, with minimal or no visual impact depending on the solutions adopted. This innovative technology ensures high performance in terms of energy efficiency and quiet operation, providing excellent climate comfort while fully preserving architectural integrity.

ELFO

IDRA NEXT

IDRA ECO

IDRA RING

R3

PICCOLO

CAIO

iQ

iSTYLE

MOKA

ATHENA-C

VAIA



ELFO es el climatizador de la serie **INVISIBLES** con unidad condensadora oculta, concebido para instalaciones sensibles, edificios protegidos, de valor arquitectónico y en centros históricos.

VENTAJAS

- Respeto del decoro arquitectónico
- Desaparición de las unidades condensadoras a la vista
- Ideal para centros históricos
- Fácil instalación
- Ahorro energético
- Alta eficiencia en calefacción y refrigeración



ELFO is the air conditioner of the **INVISIBLES** serie with concealed condensing unit, designed for sensitive installations, for constrained buildings of architectural value and in historic centers.

ADVANTAGES

- Architectural decoration
- Disappearance of visible condensing units
- Excellent for historical centres
- Easy installation
- Energy saving
- High efficiency in heating and cooling

Para obtener un alto rendimiento y un consumo reducido, los climatizadores invisibles Tekno Point utilizan compresores y componentes electrónicos de los mejores fabricantes.

To achieve high performance and low energy consumption, Tekno Point Invisible air conditioners use compressors and electronics from the best manufacturers.



Solución definitiva: reducción del impacto estético de los aparatos de aire acondicionado.

Definitive solution: reducing the aesthetic impact of air conditioners.



Nueva clasificación energética de los climatizadores de doble conducto.

New energy classification of double duct air conditioners.

	EER		COP
A+++	> 4,1	A+++	> 4,6
A++	> 3,6	A++	> 4,1
A+	> 3,1	A+	> 3,6
A	> 2,6	A	> 3,1
B	> 2,4	B	> 2,6
C	> 2,1	C	> 2,4
D	> 1,8	D	> 2,0

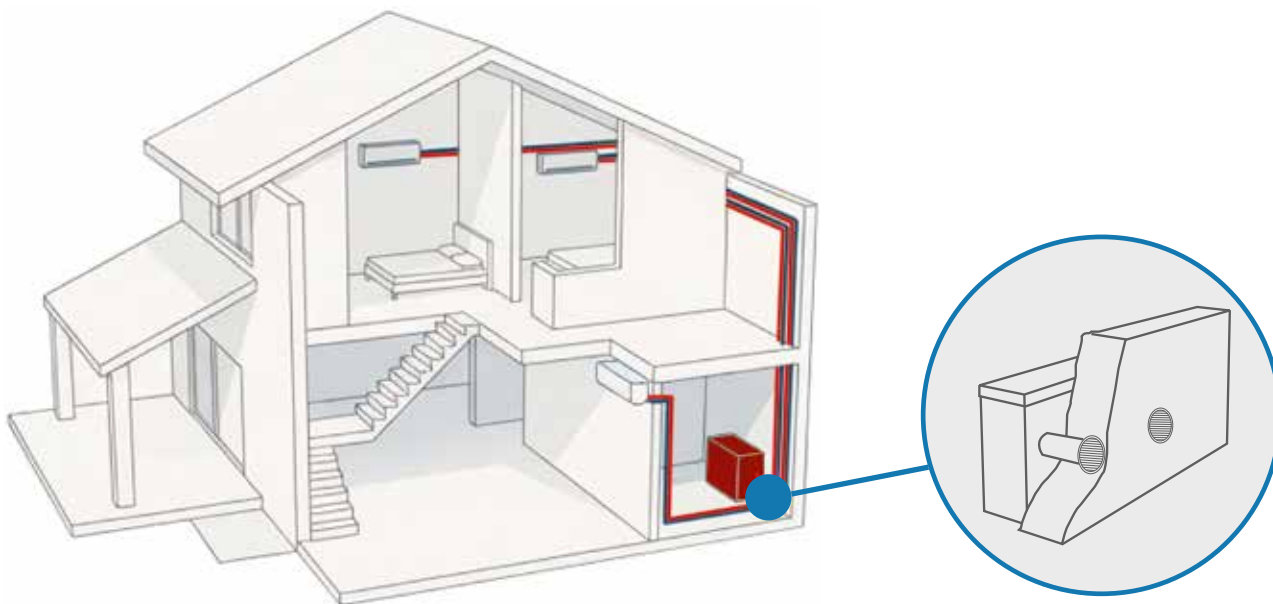

monosplit	dual split	trial split	Elfo VRF
12.000 BTU - 3,5 kW 18.000 BTU - 5,2 kW	14.000 BTU - 4,1 kW 18.000 BTU - 5,2 kW	24.000 BTU - 7,0 kW	34.100 BTU - 10,0 kW - max 5 UI 48.000 BTU - 14,0 kW - max 8 UI 55.000 BTU - 16,0 kW - max 9 UI 76.000 BTU - 22,4 kW - max 13 UI

Elige la unidad interior compatible - Choose indoor units that can be matched

SPLIT WALL MOUNTED	CANALIZADO DUCT UNIT	CASSETTE CASSETTE	CONSOLA CONSOLLE	

Elige la unidad interior VRF compatible - VRF indoor units that can be matched

SPLIT WALL MOUNTED	CASSETTE CASSETTE	TECHO/SUELO CEILING/FLOOR	CONDUCTO DE BAJA PRESIÓN ESTÁTICA LOW STATIC PRESSURE DUCTED UNIT	CONDUCTO DE PRESIÓN ESTÁTICA MEDIA/ALTA MED/HIGH STATIC PRESSURE DUCTED UNIT



ELFO mono es el sistema de climatización con bomba de calor ideal para refrigerar, calentar y deshumidificar apartamentos, oficinas, locales comerciales, en centros históricos y donde no está permitido instalar la unidad condensadora en el exterior. Compacto, silencioso y eficiente, se integra de forma discreta en el interior del edificio y se combina con unidades internas murales, canalizadas, de cassette o consola.



ELFO mono is the exclusive air-conditioning system with heat pump ideal for cooling, heating and dehumidifying offices and business premises in prestigious buildings in town centers where it's not allowed to install condensing units externally. Compact, quiet and efficient, Elfo fits discreetly inside the building, and combined with indoor wall units, duct, cassette or console.

ELFO MONOSPLIT

UNIDAD CONDENSADORA OCULTA DC INVERTER INVISIBLE CONDENSING UNIT DC INVERTER



ELFO-12



ELFO-18

ELFO 12.000 BTU - 3,5 kW
ELFO 18.000 BTU - 5,2 kW

combinable - combined with:

Split mural
Wall mounted

SKIV
IMAGINE



Canalizados
Duct unit

DUCT-V
DBIS PLUS



Cassette de 4 vías
Cassette

CASK-CV
CASK-V



Consola
Console

CNS



Datos técnicos y descripciones disponibles en la sección "**Unidades interiores ELFO e IDRA**".
Technical data and descriptions available in the "ELFO and IDRA Indoor Units" section.

ELFO MONOSPLIT

CLIMATIZADOR INVISIBLE AIRE-AIRE

DOUBLE DUCT AIR-AIR

INVISIBLE AIR CONDITIONER



LOS INVISIBLES
THE INVISIBLES

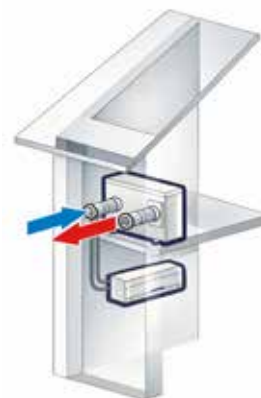

ELFO Monosplit DC inverter					
Código - Code		-		ELFO-12	ELFO-18
Alimentación - Power Supply		V-Hz-Ph		230-50-1	230-50-1
Protección contra sobrecorriente - Max Overcurrent Protection		A		16	25
Sección cables alimentación - Power cable cross-sectional area		mm ²		1,5	2,5
Refrigeración Cooling	Potencia Capacity	Nominal	W/BTU	3500/12000	5200/17742
		Min/Max	W	4200/1400	2100/5900
	Consumo eléctrico Max power absorbtion	Nominal	W	1420	1980
		Min/Max	W	560/1910	560/2690
EER		W/W		2,56	2,62
Clase energética - Energy class		-		A	A
Calefacción Heating	Potencia Capacity	Nominal	W/BTU	3500/12000	5200/17742
		Min/Max	W	1400/4300	2550/5950
	Consumo eléctrico Max power absorbtion	Nominal	W	1270	1700
		Min/Max	W	800/1750	800/2530
COP		W/W		2,81	3,01
Clase energética - Energy class		-		B	B
Presión sonora - Sound level		dB(A)		59	57
Potencia sonora - Sound power		dB(A)		70	73
Método de regulación - Throttling method		-		EEV	EEV
Dimensiones - Dimensions (LxPxH)		mm		786 x 315 x 558	1055 x 455 x 702
Peso - Weight		Kg		41	72
Compresor - Compressor		Marca		Panasonic	Panasonic
Refrigerante Refrigerant	Tipo - Type		-	R32	R32
	Precarga - Precharge		Kg	0,75	1,00
	Carga adicional - Add. Charge		gr/m	22	22
Tuberías frigoríficas Refrigeration piping	Dimensiones - Dimensions		inch	1/4" - 3/8"	1/4" - 1/2"
	Distancia máx con precarga Max distance with pre-charge		m	7,5	10
	Distancia máxima admisible entre UI y UE / tot Max allowable distance between UI and UE / tot.		m	10	20
	Desnivel máximo admisible entre U.I. y U.E. Max elevation difference between IU and OU		m	5	5
Orificios de aire - Air connections		mm/nr		Ø200 x2	Ø200 x4
Distancia máxima recomendada entre Elfo y la pared perimetral sin ventilador auxiliar Max distancer between Elfo and outside wall surface without additional fan		m		4/8	2/6
Temperatura ajustable - Set temperature range		°C		+16~+31	+16~+31
Ambiente exterior con KIT BT ELFO (refrig/calef) Outdoor Environment with KIT BT ELFO (cool/heat)		°C		-15~-55 / -20~-30	-15~-55 / -20~-30

El uso de la **bandeja de recogida de condensados** es obligatorio para las máquinas utilizadas para calefacción.

Se recomienda el uso de los **anillos metálicos de conexión** entre la unidad Elfo y los tubos de expulsión y retorno, cod. ANELFO, opcional.

Si consiglia l'uso delle **griglie di copertura fori esterni GRIELFO**, optional.

Condiciones de prueba: Refrigeración: Int. 27 °C B.S. - Ext. 35 °C B.S. / 24 °C B.H. Calefacción: Int. 20 °C B.S. - Ext. 7 °C B.S. / 6 °C B.H.

Use of the condensate drip tray is mandatory for machines used for heating.

We recommend the use of **metal rings for connection** between the Elfo unit and the expulsion and recovery pipes cod. ANELFO, optional.

We recommend the use of the **GRIELFO external holes cover grilles**, optional.

Test conditions: Cooling: Int. 27°C D.B. - East 35°C B.S. / 24°C W.B. Heating: Int. 20°C D.B. - Ext 7°C B.S. / 6°C W.B.



ELFO multi es el sistema de climatización con bomba de calor ideal para refrigerar, calentar y deshumidificar apartamentos, oficinas, locales comerciales, centros históricos y lugares donde no está permitido instalar la motocondensadora en el exterior. Compacto, silencioso y eficiente, se integra de forma discreta en el interior del edificio y se combina con unidades internas murales, canalizadas, de cassette o consola.



ELFO multi is the exclusive air-conditioning system with heat pump ideal for cooling, heating and dehumidifying offices and business premises in prestigious buildings and town centers where it's not allowed to install condensing units externally. Compact, quiet and efficient fits discreetly inside the building, and is combined with indoor wall units, ducted, cassette or console.

ELFO MULTISPLIT

UNIDAD CONDENSADORA OCULTA DC INVERTER INVISIBLE CONDENSING UNIT DC INVERTER



ELFO2-14



ELFO2-18 | ELFO3-24

ELFO2 14.000 BTU - 4,1 kW
ELFO2 18.000 BTU - 5,2 kW
ELFO3 24.000 BTU - 7,0 kW
 combinable - combined with:

Split mural
Wall mounted

SKIV
IMAGINE



Canalizados
Duct unit

DUCT-V
DBIS PLUS



Cassette de 4 vías
Cassette

CASK-CV
CASK-V



Consola
Console

CNS



Datos técnicos y descripciones disponibles en la sección "**Unidades internas ELFO e IDRA**".
 Technical data and descriptions available in the "ELFO and IDRA Indoor Units" section.

ELFO MULTISPLIT

CLIMATIZADOR INVISIBLE AIRE-AIRE

DOUBLE DUCT AIR-AIR INVISIBLE

AIR CONDITIONER



LOS INVISIBLES
THE INVISIBLES

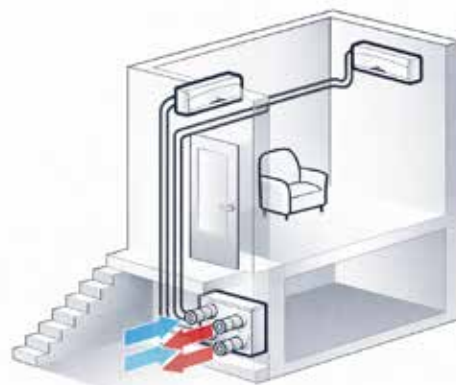

ELFO Multiplit DC inverter						
Código - Code		-		ELFO2-14	ELFO2-18	ELFO3-24
Alimentación - Power Supply		V-Hz-Ph		230-50-1	230-50-1	230-50-1
Protección contra sobrecorriente - Max Overcurrent Protection		A		16	25	25
Sección cables alimentación - Power cable cross-sectional area		mm ²		1,5	2,5	2,5
Refrigeración Cooling	Potencia Capacity	Nominal	W/BTU	4100/13990	5200/17742	7000/23884
		Min/Max	W	1000/4300	2100/5900	2300/8450
	Consumo eléctrico Max power absorbtion	Nominal	W	1500	1980	2690
		Min/Max	W	700/1700	560/2690	1050/3360
EER		W/W		2,73	2,62	2,63
Clase energética - Energy class		-		A	A	A
Calefacción Heating	Potencia Capacity	Nominal	W/BTU	4400/15000	5200/17742	7000/23884
		Min/Max	W	1300/4800	2550/5950	3500/8600
	Consumo eléctrico Max power absorbtion	Nominal	W	1600	1700	2250
		Min/Max	W	700/2000	800/2530	950/3210
COP		W/W		2,75	3,01	3,11
Clase energética - Energy class		-		B	B	A
Presión sonora - Sound level		dB(A)		46	63	63
Potencia sonora - Sound power		dB(A)		57	73	73
Método de regulación - Throttling method		-		EEV	EEV	EEV
Dimensiones - Dimensions (LxPxH)		mm		996 x 405 x 558	1055 x 455 x 702	1055 x 455 x 702
Peso - Weight		Kg		55	72	81
Compresor - Compressor		Marca		Panasonic	Panasonic	Mitsubishi
Refrigerante Refrigerant	Tipo - Type		-	R32	R32	R32
	Precarga - Precharge		Kg	1,00	1,00	1,3
	Carga adicional - Add. Charge		gr/m	20	22	22
Tuberías frigoríficas Refrigeration piping	Dimensiones - Dimensions		inch	1/4"-3/8" x2	1/4"-3/8" x2	1/4"-3/8" x3
	Distancia máx con precarga Max distance with pre-charge		m	10	10	10
	Distancia máxima admisible entre UI y UE / tot Max allowable distance between UI and UE / tot.		m	10 / 20	10 / 20	10 / 30
	Desnivel máximo admisible entre U.I. y U.E. Max elevation difference between IU and OU		m	5	5	5
Orificios de aire - Air connections		mm/nr		Ø200 x2	Ø200 x4	Ø200 x4
Distancia máxima recomendada entre Elfo y la pared perimetral sin ventilador auxiliar Max distancer between Elfo and outside wall surface without additional fan		m		2/6	2/6	2/6
Temperatura ajustable - Set temperature range		°C		+16~+31	+16~+31	+16~+31
Ambiente exterior con KIT BT ELFO (refrig/calef) Outdoor Environment with KIT BT ELFO (cool/heat)		°C		-15-55 / -20-30	-15-55 / -20-30	-15-55 / -20-30

El uso de la **bandeja de recogida de condensados** es obligatorio para las máquinas utilizadas para calefacción.

Se recomienda el uso de los **anillos metálicos de conexión** entre la unidad Elfo y los tubos de expulsión y retorno, cod. ANELFO, opcional.

Si consiglia l'uso delle **griglie di copertura fori esterni GRIELFO**, optional.

Condiciones de prueba: Refrigeración: Int. 27 °C B.S. - Ext. 35 °C B.S. / 24 °C B.H. Calefacción: Int. 20 °C B.S. - Ext. 7 °C B.S. / 6 °C B.H.

Use of the condensate drip tray is mandatory for machines used for heating.

We recommend the use of **metal rings for connection** between the Elfo unit and the expulsion and recovery pipes cod. ANELFO, optional.

We recommend the use of the **GRIELFO external holes cover grilles**, optional.

Test conditions: Cooling: Int. 27°C D.B. - East 35°C B.S. / 24°C W.B. Heating: Int. 20°C D.B. - Ext 7°C B.S. / 6°C W.B.

ACCESORIOS OPCIONALES PARA ELFO OPTIONAL ACCESSORIES FOR ELFO

	Código Code	Descripción Description	Modelo Model
	EL2VASC	Bandeja de recogida de condensados. Dimensiones mm 925x380x25 Condensate collection tray Dimensions mm 925x380x25	ELFO-12 ELFO2-14
	EL3VASC	Bandeja de recogida de condensados. Dimensiones mm 1060x380x25 Condensate collection tray Dimensions mm 1060x380x25	ELFO-18 ELFO2-18 ELFO3-24
	SP10	Soportes de polipropileno antichoque, autoextinguible y estabilizado contra los rayos UV. Completos con tuercas y tornillos para la fijación (4 piezas). Impact-resistant, self-extinguishing polypropylene supports, UV-stabilized. Supplied complete with nuts and bolts for fastening (4 pieces).	ELFO-12 ELFO2-14 ELFO-18 ELFO2-18 ELFO3-24
	R-552230	Colector de acero galvanizado. Dimensiones (LxP) 550x230 mm - Ø 300 mm . Integra los dos racores Ø 200 en una única salida Ø 300. Galvanized steel manifold. Dimensions (WxD) 550x230 mm - Ø 300 mm . Combines the two Ø 200 outlets into a single Ø 300 outlet.	ELFO-18 ELFO2-18 ELFO3-24
	ANELFO	Anillos de conexión para Elfo. Diámetro 200 mm. Facilita la conexión entre Elfo y el conducto de aire. Connecting rings for Elfo. Diameter mm 200. Makes connection between ELFO and air duct easier.	ELFO (all models)
	SIL2001000B	Silenciadores flexibles circulares. Dimensiones Ø 200 mm, L. 1000 mm . Atenuación 250 Hz 9 dB (A). Circular flexible silencers - Dimensions Ø 200 mm, L. 1000 mm . Attenuation 250Hz 9 dB (A)	ELFO (all models)
	SIL200500B	Silenciadores flexibles circulares. Dimensiones Ø 200 mm, L. 500 mm . Atenuación 250Hz 4.5 dB (A) Circular flexible silencers - Dimensions Ø 200 mm, L. 500 mm . Attenuation 250Hz 4.5 dB (A)	ELFO (all models)
	SIL3001000B	Silenciadores flexibles circulares. Dimensiones Ø 300 mm, L. 1000 mm . Atenuación 250Hz 9 dB (A) Circular flexible silencers - Dimensions Ø 300 mm, L. 1000 mm . Attenuation 250Hz 9 dB (A)	R-552230
	SIL300500B	Silenciadores flexibles circulares. Dimensiones Ø 300 mm, L.500 mm . Atenuación 250Hz 4.5 dB (A) Circular flexible silencers - Dim. Ø 300 mm, L.500 mm . Attenuation 250Hz 4.5 dB (A)	R-552230
	AXC250	Ventilador auxiliar (de 1 velocidad). Se aplica a cada canal de expulsión cuando es necesario aumentar la distancia entre Elfo y la pared exterior. Debe solicitarse en el pedido. No apto para reducción Ø300. Auxiliary fan (1 speed). It is applied to each ejection channel when it is necessary to increase the distance between Elfo and external wall. It must be requested when ordering. Not suitable for Ø300 reduction.	ELFO (all models)
	KIT BT ELFO	KIT DE BAJA TEMPERATURA PARA ELFO En configuración estándar, ELFO está indicada para las estaciones intermedias o como integración a otros sistemas. Para su uso en invierno como única fuente de calefacción, especialmente en climas fríos y/o húmedos, es necesario el Kit de Baja Temperatura, instalado bajo pedido en fábrica. El kit mejora la eficiencia en calefacción y reduce los ciclos de desescarche. LOW TEMPERATURE KIT FOR ELFO In standard configuration, ELFO is suitable for mid-season use or as an integration with other heating systems. For winter operation as the sole heating source, especially in cold and/or humid climates, the Low Temperature Kit is required. Factory-installed on request, it improves heating efficiency, condensate drainage and reduces defrost cycles.	ELFO (all models)
	GRIELFO	Rejilla de material flexible para una fácil instalación desde el interior, Ø 200 mm. Grid in foldable material for easy installation from the inside mm 200.	ELFO (all models)

A PROPÓSITO DE ELFO ABOUT ELFO

CONFIGURACIÓN DE ELFO EN CALEFACCIÓN ELFO CONFIGURATION IN HEATING MODE

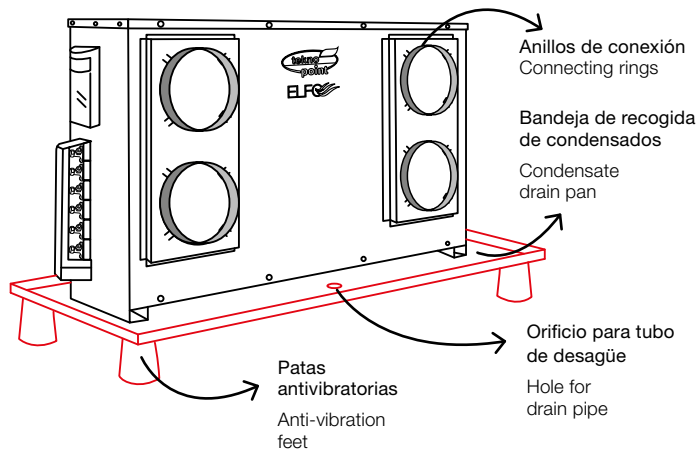

Cuando ELFO se instala como sistema de calefacción, es fundamental aplicar la bandeja de recogida de condensados. La condensación debe canalizarse correctamente hacia un desagüe dedicado, respetando las indicaciones de instalación, para garantizar el correcto funcionamiento del sistema.

When ELFO is installed as a heating system, it is essential to install the condensate collection tray. The condensate must be properly conveyed to a dedicated drain, in accordance with the installation instructions, to ensure the correct operation of the system.

COLECTOR Ø300 Ø300 MANIFOLD

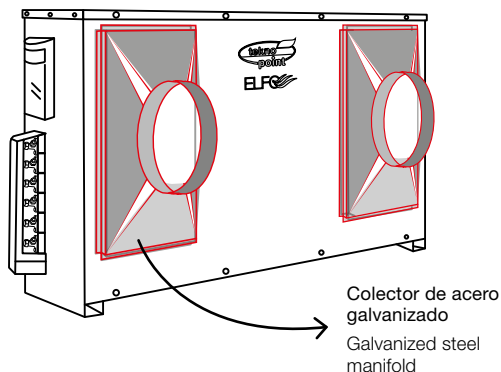

El colector R-552230 es un elemento de conexión en acero galvanizado diseñado para optimizar las conexiones aerúlicas posteriores de la unidad ELFO. Permite canalizar los pares de orificios en una única salida de 300 mm de diámetro, reduciendo el número total de conductos necesarios y utilizando una sola pareja de canalizaciones hacia el exterior.

The R-552230 manifold is a galvanized steel connection component designed to optimize the rear air connections of the ELFO unit. It enables the paired openings to be merged into a single 300 mm diameter outlet, reducing the total number of ducts required and using only one pair of ducts to the outside.

SILENCIADORES SILENCERS

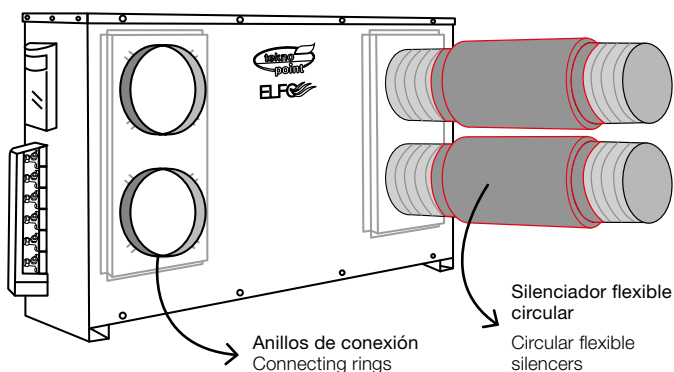

En instalaciones en las que la expulsión se realiza en zonas habitadas que requieren un bajo nivel de ruido, es posible instalar externamente a la unidad condensadora, en la salida de expulsión, un silenciador circular para reducir la sonoridad de la unidad hacia el exterior.

In installations where air discharge takes place in inhabited areas requiring particularly low noise levels, a circular silencer can be installed externally on the discharge side of the condensing unit in order to reduce the noise emitted outdoors.

A PROPÓSITO DE ELFO ABOUT ELFO

EJEMPLOS DE INSTALACIÓN INSTALLATION EXAMPLES

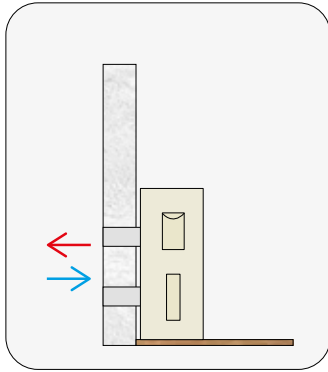

A ras de pared
Flush wall installation

La unidad Elfo se instala directamente contra la pared perimetral. El aire se aspira y se expulsa mediante orificios pasantes realizados en la pared exterior, garantizando la conexión directa con el exterior.

The Elfo unit is installed directly against the perimeter wall. Air intake and discharge occur through through-wall openings made in the external wall, ensuring a direct connection to the outdoors.

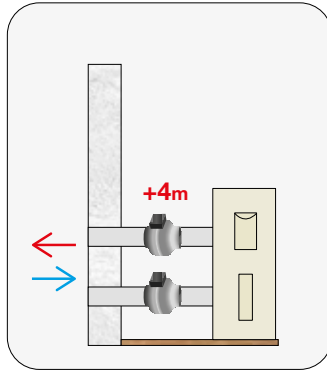

Con ventiladores auxiliares
With auxiliary fans

Si las canalizaciones de salida hacia el exterior superan las longitudes indicadas para cada modelo de Elfo, gracias a los ventiladores auxiliares instalables en las tuberías de impulsión, es posible prolongarlas hasta 4 metros.

If the outlet ducting to the outside exceeds the declared lengths for each Elfo model, the auxiliary fans that can be installed on the supply ducts allow the extension to be increased up to 4 metres.

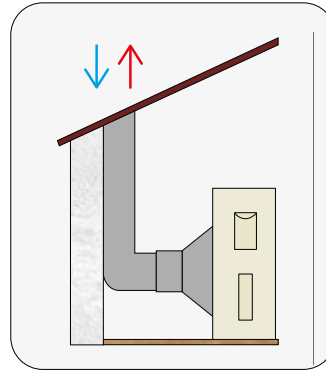

Con salida a techo
With roof outlet

La unidad Elfo se instala en el ático. Mediante tuberías conectadas a la cubierta, el aire se aspira y se expulsa directamente hacia el exterior.

The Elfo unit is installed in the attic. Through ductwork connected to the roof, air is directly drawn in and discharged to the outside.

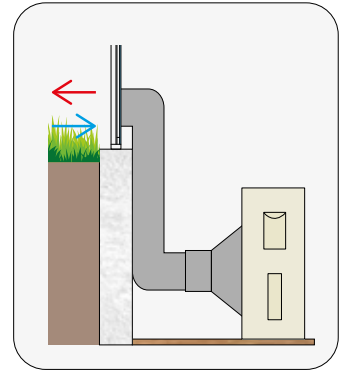

Semisótano
In the basement

La unidad Elfo se instala en el semisótano. Mediante tuberías de 300 mm de diámetro, el aire se aspira y se expulsa a través de una ventana con salida al exterior.

The Elfo unit is installed in the basement. Using Ø300 mm ductwork, air is supplied and discharged through a window opening to the outside.

SECUENCIA DE INSTALACIÓN RECOMENDADA DE LOS ACCESORIOS ELFO RECOMMENDED INSTALLATION SEQUENCE OF ELFO ACCESSORIES

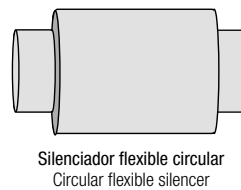
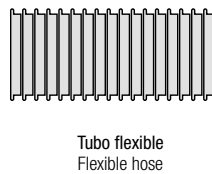
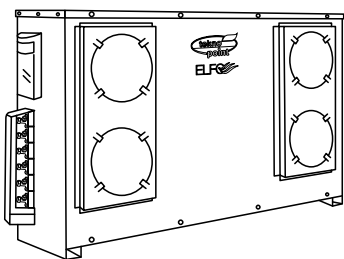

A) CASO DE ESTUDIO: AVIGNÓN - FRANCIA

A) CASE STUDY: AVIGNONE - FRANCE

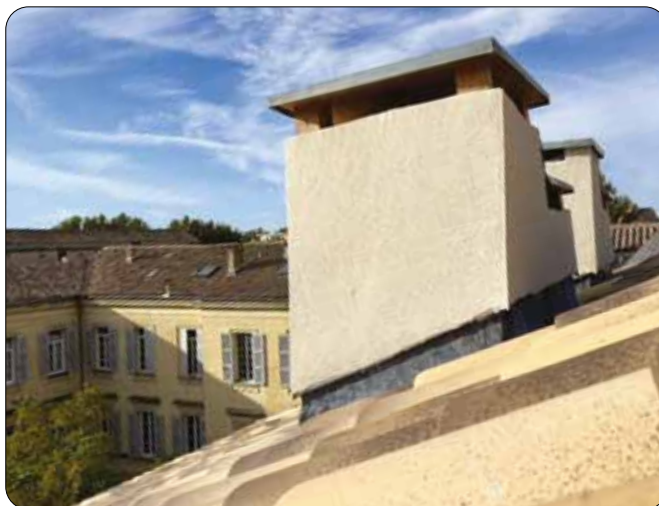

Ejemplo de instalación de un Elfo3-24 en ático con colector R-552230 y salida a techo.

Example of an Elfo3-24 installation in an attic with R-552230 manifold and roof outlet.

B) CASO DE ESTUDIO: PARMA

B) CASE STUDY: PARMA



Ejemplo de instalación de un Elfo-18 con tuberías flexibles que permiten una adaptación óptima.

Example of an Elfo-18 installation with flexible ducts allowing optimal adaptability.



Elfo VRF es el modelo perfecto para instalaciones en el ámbito comercial donde se requiere mayor potencia y un elevado número de unidades interiores. Diseñado para una fácil instalación en entornos comerciales donde no está permitido el uso de condensadores externos.



Elfo VRF is the perfect model for commercial installations where higher capacities and numerous indoor units are required. Designed for easy installation in commercial environments where the use of external condensers is not allowed.



UNIDAD MOTOCONDENSADORA CENTRÍFUGA OCULTA
INVISIBLE CENTRIFUGAL CONDENSING UNIT

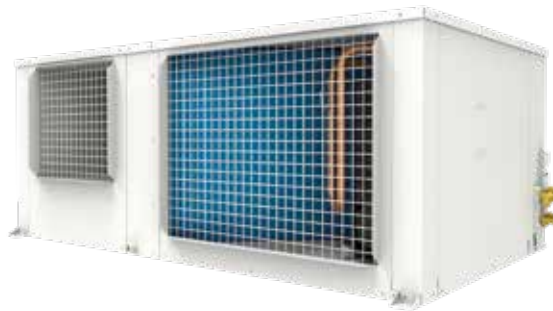

ELFO-35H | ELFO-48H | ELFO-55H

ELFO VRF 35.000 BTU - 10 kW
ELFO VRF 48.000 BTU - 14 kW
ELFO VRF 55.000 BTU - 16 kW
ELFO VRF 76.000 BTU - 22,4 kW
combinable - combined with:

Split mural
Wall mounted



Techo/Suelo
Floor ceiling unit



Cassette de 4 vías
4-way cassette



Cassette round-flow
Round-flow cassette

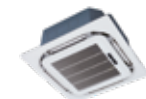

Conducto de baja presión estática
Low static pressure duct unit



Conducto de presión estática media
Medium static pressure duct unit

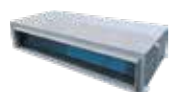

Conducto de alta presión estática
High static pressure duct unit



ELFO VRF CLIMATIZADOR INVISIBLE AIRE-AIRE

AIR-AIR INVISIBLE AIR CONDITIONER



R410A

LOS INVISIBLES
THE INVISIBLES



ELFO Volumen de Refrigerante Variable - Variable Refrigerant Flow							
Código - Code		-	ELFO-35H	ELFO-48H	ELFO-55H	ELFO-76H	
Máx unidades internas - Max Indoor Units		-	5	8	9	13	
Alimentación - Power Supply		V-Hz-Ph	230-50-1	380-50-3	380-50-3	380-50-3	
Cable de señal - Signal Cable		mm ²	3x1 core shielded cable	3x1 core shielded cable	3x1 core shielded cable	3x1 core shielded cable	
Sección cables alimentación - Power cable cross-sectional area		mm ²	3x6	5x2,5	5x2,5	5x6	
Refrigeración Cooling	Potencia Capacity	Nominal	W/BTU	10000/34100	14000/48000	16000/55000	22400/76400
	Consumo eléctrico Max power absorbtion	Nominal	W	4300	6800	7300	11500
	EER		W/W	2,33	2,06	2,2	1,95
Clase energética - Energy class		-	n.d.	n.d.	n.d.	n.d.	
Calefacción Heating	Potencia Capacity	Nominal	W/BTU	11200/38200	14000/48000	16000/55000	24000/81900
	Consumo eléctrico Max power absorbtion	Nominal	W	4100	5600	6000	9500
	COP		W/W	2,73	2,50	2,67	2,53
Clase energética - Energy class		-	n.d.	n.d.	n.d.	n.d.	
Presión sonora - Sound level		dB(A)	≤ 65	≤ 72	≤ 72	≤ 67	
Potencia sonora - Sound power		dB(A)	≤ 76	≤ 83	≤ 83	≤ 78	
Método de regulación - Throttling method		-	EEV	EEV	EEV	EEV	
Dimensiones - Dimensions (LxPxH)		mm	1508 x 927 x 583	1508 x 927 x 583	1508 x 927 x 583	2001 x 1656 x 675	
Peso - Weight		Kg	147	173	173	290	
Compresor - Compressor		Marca	GMCC	GMCC	GMCC	MITSUBISHI	
Refrigerante Refrigerant	Tipo - Type	-	R410A	R410A	R410A	R410A	
	Precarga - Precharge	Kg	2,6	3,5	3,5	7,0	
	Carga adicional - Add. Charge	gr/m	n.d.	n.d.	n.d.	n.d.	
Tuberías frigoríficas Refrigeration piping	Dimensiones - Dimensions	inch	3/8"-5/8"	3/8"-5/8"	3/8"-5/8"	3/8"-3/4"	
	Distancia máx con precarga Max distance with pre-charge	m	n.d.	n.d.	n.d.	n.d.	
	Distancia máxima admisible entre UI y UE / tot Max allowable distance between UI and UE / tot.	m	70 / 100	70 / 100	70 / 100	70 / 100	
	Desnivel máximo admisible entre U.I. y U.E. Max elevation difference between IU and OU	m	30 / 20	30 / 20	30 / 20	30 / 20	
Caudal de aire - Air flow		m ³ /h	3600	3600	5000	8000	
Orificios de aire - Air connections		mm/nr	Inlet 480 x 550 x1 Outlet 390 x 340 x1	Inlet 480 x 550 x1 Outlet 390 x 340 x1	Inlet 480 x 550 x1 Outlet 390 x 340 x1	Inlet 480 x 550 x1 Outlet 390 x 340 x2	
Presión estática útil - Static pressure		Pa	≤ 90	≤ 90	≤ 90	≤ 90	
Distancia máxima recomendada entre Elfo y la pared perimetral Max distancer between Elfo and outside wall surface		m	≤ 2	≤ 2	≤ 2	≤ 2	
Temperatura ajustable - Set temperature range		°C	+16~+32	+16~+32	+16~+32	+16~+32	
Rango de temperatura exterior de funcionamiento (refrig/calef) External operating temperature (heat/cool)		°C	-5~+50 / -15~+30	-5~+50 / -15~+30	-5~+50 / -15~+30	-5~+50 / -15~+30	

- El intervalo de temperatura en refrigeración va de -5 °C a 50 °C.
El intervalo de temperatura de funcionamiento en calefacción va de -15 °C a 30 °C.
- Condiciones de refrigeración: lado interior 27 °C (80,6 °F) B.S., 19 °C (60 °F) B.U.
Lado exterior 35 °C (95 °F) B.S..
- Condiciones de calefacción: lado interior 20 °C (68 °F) B.S., 15 °C (44,6 °F) B.U.
Lado exterior 7 °C (42,8 °F) B.S..
- Caudal de aire 14 kW: medido en modo silencioso y con una presión estática de 50 Pa.

- Cooling operating temperature range is from -5°C to 50°C. Heating operating temperature range is from -15°C to 30°C.
- The cooling conditions: indoor side 27°C (80.6°F) DB, 19°C (60°F) W.B. outdoor side 35°C (95°F) D.B..
- The heating conditions: indoor side 20°C (68°F) DB, 15°C (44.6°F) W.B. outdoor side 7°C (42.8°F) D.B..
- 14kW air flow: measured at silent mode and 50Pa static pressure.

ACERCA DE ELFO VRF ABOUT ELFO VRF

¿POR QUÉ ELEGIR ELFO? WHY CHOOSE ELFO VRF?



Las ventajas de ELFO VRF:

1. Perfecto para grandes superficies
2. Dimensiones reducidas y funcionamiento silencioso
3. Elevado número de unidades interiores conectables

The advantages of ELFO VRF:

1. Perfect for large surfaces
2. Small size and low noise
3. High number of connectable indoor units

Posibilidad de controlar la entrada y la salida del aire

Possibility to manage the air inlet and outlet

Según las necesidades de instalación de la unidad y las posibilidades de salida al exterior de los conductos de aire, es posible desplazar los paneles para facilitar las operaciones.

Based on the installation requirements of the unit and the available options for routing the air ducts to the outside, the panels can be repositioned to facilitate the operations.

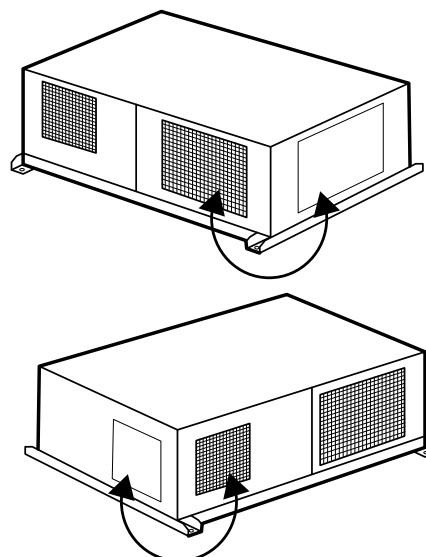

Alta presión estática de la unidad condensadora

High static pressure of the condensing unit

Los ventiladores centrífugos permiten trabajar con una amplia gama de presiones estáticas externas, ofreciendo la posibilidad de canalizar la unidad para mantenerla oculta. Presión estática hasta 90 Pa.

Centrifugal fans allow working with a wide range of external static pressures, providing the possibility to duct the unit in order to keep it hidden. ESP up to 90Pa.

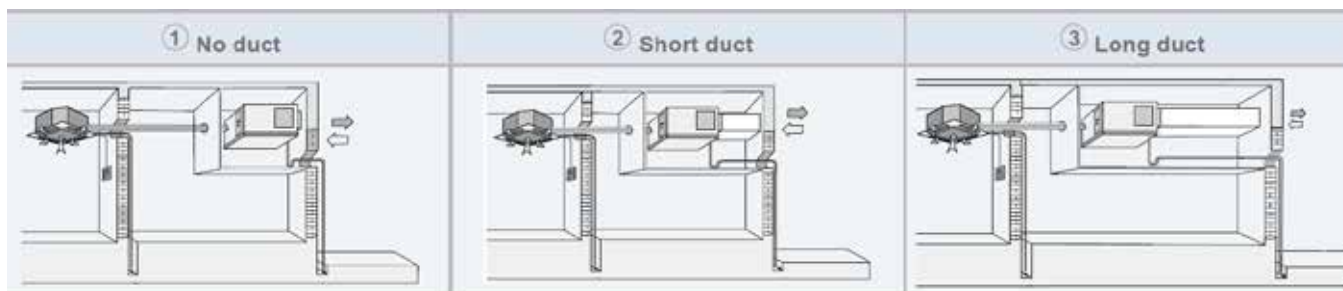

**COMBINABLE:
COMBINED WITH**

	Cassette	Cassette (Round-Flow)	Cassette (Compact)	Wall mounted	Floor Ceiling	Ducted low press.	Ducted med. press.	Ducted high press.
Capacity kW								
2.2			•	•		•		
2.8	•	•	•	•		•		
3.6	•	•	•	•		•		
4.5	•	•	•	•	•	•		
5.6	•	•		•	•	•		
7.1	•	•		•	•	•	•	•
8.0	•	•			•		•	•
9.0	•	•			•		•	•
10.0	•	•					•	•
11.2	•	•			•			
12.0							•	•
12.5	•	•						
14.0	•	•			•			
15.0							•	
16.0	•	•			•			

**CONECTIVIDAD
CONNECTIVITY**

SMART CONTROL APP

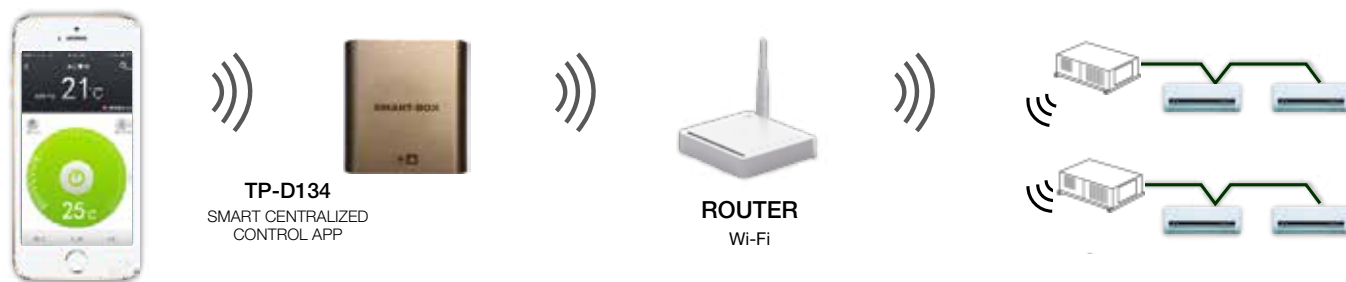

REMOTE CONTROLLERS

TP/03
Mando a distancia inalámbrico
Wireless remote controllers

TPVE-06 TPVE-D178
Controles cableados
Wired controllers

TP-D099 TP-JKQ-015
Mandos cableados centralizados
Centralized wired controllers

ELFO VRF - UNIDADES INTERIORES INDOOR UNITS

SPLIT MURAL

Wall mounted



Unidad interior mural, de diseño simple y elegante, equipada con motor DC, regulación progresiva de la ventilación y filtro de aire. Válvula de expansión integrada.

Wall-mounted indoor unit with a simple and elegant design, equipped with a DC motor, progressive fan speed control, and air filter. Expansion valve built-in.

Unidad interior de pared - Wall mounted unit

Código - Code		-	TPV-D22G/HR1-GSB	TPV-D28G/HR1-GSB	TPV-D36G/HR1-GSB	TPV-D45G/HR1-GSC	TPV-D56G/HR1-GSC	TPV-D71G/HR1-GSC
Alimentación - Power Supply		V-Hz-Ph	230-50-1	230-50-1	230-50-1	230-50-1	230-50-1	230-50-1
Refrigeración Cooling	Potencia Capacity	W/BTU	2200/7500	2800/9500	3600/12200	4500/15300	5600/19100	7100/24200
Calefacción Heating	Potencia Capacity	W/BTU	2500/8500	3200/10900	4000/13600	5000/17000	6200/21100	7800/26600
Caudal de aire - Air flow		m³/h	540	540	600	600	920	920
Presión sonora - Sound level		dB(A)	24~33	24~33	24~33	33~40	35~43	35~43
Potencia sonora - Sound power		dB(A)	35~44	35~44	35~44	44~51	46~54	46~54
Dimensiones - Dimensions (LxPxH)		mm	800x190x281	800x190x281	800x190x281	900x216x296	900x216x296	1080x221x304
Peso - Weight		Kg	12	12	12	12	16	16
Tuberías frigoríficas Refrigeration piping	Dimensiones Dimensions	inch	1/4"-3/8"	1/4"-3/8"	1/2"-1/4"	1/2"-1/4"	1/2"-1/4"	3/8"-5/8"

TECHO/SUELO

Ceiling/floor



Unidad interior de techo/suelo, equipada con motor AC, regulación progresiva de la ventilación y filtro de aire. Válvula de expansión integrada.

Ceiling/floor indoor unit, equipped with an AC motor, progressive fan speed control, and air filter. Expansion valve built-in.

Unidad interior de techo - Floor ceiling unit

Código - Code		-	TPV-V45UA/HR1-LDBA	TPV-V56UA/HR1-LDBA	TPV-V71UA/HR1-LDBB	TPV-V80UA/HR1-LDBB	TPV-V90UA/HR1-LDBC	TPV-V112UA/HR1-LDBC	TPV-V140UA/HR1-LDBC	TPV-V160UA/HR1-LDBC
Alimentación - Power Supply		V-Hz-Ph	230-50-1	230-50-1	230-50-1	230-50-1	230-50-1	230-50-1	230-50-1	230-50-1
Refrigeración Cooling	Potencia Capacity	W/BTU	4500/15300	5600/19100	7100/24200	8000/27200	9000/30700	11200/38200	14000/47700	16000/54500
Calefacción Heating	Potencia Capacity	W/BTU	5000/17000	6300/21400	8000/27200	8800/30000	10000/34100	12500/42600	15000/51100	17000/58000
Caudal de aire - Air flow		m³/h	950	950	1300	1300	1500	2300	2300	2300
Presión sonora - Sound level		dB(A)	37~46	37~46	39~48	39~48	44~50	45~52	45~52	45~52
Potencia sonora - Sound power		dB(A)	48~57	48~57	50~59	50~59	55~61	56~63	56~63	56~63
Dimensiones - Dimensions (LxPxH)		mm	1245x680x240	1245x680x240	1245x680x240	1245x680x240	1245x680x240	1670x680x240	1670x680x240	1670x680x240
Peso - Weight		Kg	36	36	36	36	38	51	51	51
Tuberías frigoríficas Refrigeration piping	Dimensiones - Dimensions	inch	1/2"-1/4"	1/2"-1/4"	3/8"-5/8"	3/8"-5/8"	3/8"-5/8"	3/8"-5/8"	3/8"-5/8"	3/8"-5/8"

Condiciones de prueba Refrigeración: temperatura interior 27°C DB (80.6°F), 19°C WB (60°F); temperatura exterior 35°C DB (95°F). Calefacción: temperatura interior 20°C DB (68°F), 15°C WB (44.6°F); temperatura exterior 7°C DB (42.8°F).

Test conditions Cooling: indoor temperature 27°C DB (80.6°F), 19°C WB (60°F); outdoor temperature 35°C DB (95°F). Heating: indoor temperature 20°C DB (68°F), 15°C WB (44.6°F); outdoor temperature 7°C DB (42.8°F).

ELFO VRF - UNIDADES INTERIORES INDOOR UNITS

CONDUCTO DE BAJA PRESIÓN ESTÁTICA

Low static pressure ducted unit



La versión de baja presión estática tiene dimensiones reducidas, lo que la hace especialmente adecuada para su instalación en falsos techos. Equipada con motor DC, regulación progresiva de la ventilación y filtro de aire. Válvula de expansión integrada. Bomba de drenaje de condensados opcional.

The low static pressure version features compact dimensions, making it particularly suitable for installation in false ceilings. Equipped with a DC motor, progressive fan speed control, and air filter. Expansion valve built-in. Optional condensate drain pump.

Unidad canalizada de baja presión estática - Low static pressure unit

Código - Code		-	TPV-D22TA/HR1-C	TPV-D28TA/HR1-C	TPV-D36TA/HR1-C	TPV-D45TA/HR1-C	TPV-D56TA/HR1-C	TPV-D71TA/HR1-C
Alimentación - Power Supply		V-Hz-Ph	230-50-1	230-50-1	230-50-1	230-50-1	230-50-1	230-50-1
Refrigeración Cooling	Potencia Capacity	W/BTU	2200/7500	2800/9500	3600/12200	4500/15300	5600/19100	7100/24200
Calefacción Heating	Potencia Capacity	W/BTU	2500/8500	3200/10900	4000/13600	5000/17000	6200/21100	7800/26600
Caudal de aire - Air flow		m³/h	450	450	550	620	800	1000
Presión sonora - Sound level		dB(A)	24~29	24~29	25~32	32~37	28~38	30~39
Potencia sonora - Sound power		dB(A)	35~40	35~40	36~43	43~48	39~49	41~50
Dimensiones - Dimensions (LxPxH)		mm	814x210x467	814x210x467	814x210x467	814x210x467	1010x210x467	1214x210x467
Peso - Weight		Kg	16	16	16	16	21	25,5
Tuberías frigoríficas Refrigeration piping	Dimensiones Dimensions	inch	1/4"-3/8"	1/4"-3/8"	1/2"-1/4"	1/2"-1/4"	1/2"-1/4"	3/8"-5/8"

CONDUCTO DE PRESIÓN ESTÁTICA MEDIA

Medium static pressure ducted unit



La versión de presión estática media (variable de 70 a 30 Pa) permite variar la aspiración desde la parte inferior o desde la parte posterior de las unidades. Equipada con motor DC, regulación progresiva de la ventilación y filtro de aire.

The medium static pressure version (adjustable from 30 to 70 Pa) allows air intake from either the bottom or the rear of the unit. Equipped with a DC motor, progressive fan speed control, and air filter.

Unidad canalizada de presión estática media - Medium static pressure unit

Código - Code		-	TPV-D71TB/HR1-B	TPV-D80TB/HR1-B	TPV-D90TB/HR1-B	TPV-D100TB/HR1-B	TPV-D120TB/HR1-B	TPV-D150TB/HR1-B
Alimentación - Power Supply		V-Hz-Ph	230-50-1	230-50-1	230-50-1	230-50-1	230-50-1	230-50-1
Refrigeración Cooling	Potencia Capacity	W/BTU	7100/24200	8000/27200	9000/30700	10000/34100	12000/40900	15000/51100
Calefacción Heating	Potencia Capacity	W/BTU	8000/27200	9000/30700	10000/34100	11000/37500	13000/44300	17000/58000
Caudal de aire - Air flow		m³/h	1200	1200	1850	2000	2000	2000
Presión sonora - Sound level		dB(A)	36~41	36~41	38~43	40~44	40~44	40~44
Potencia sonora - Sound power		dB(A)	47~52	47~52	49~54	51~55	51~55	51~55
Dimensiones - Dimensions (LxPxH)		mm	1209x260x680	1209x260x680	1445x260x680	1445x260x680	1445x260x680	1445x260x680
Peso - Weight		Kg	33	33	46	46	46	46
Tuberías frigoríficas Refrigeration piping	Dimensiones Dimensions	inch	3/8"-5/8"	3/8"-5/8"	3/8"-5/8"	3/8"-5/8"	3/8"-5/8"	3/8"-5/8"

Condiciones de prueba Refrigeración: temperatura interior 27°C DB (80.6°F), 19°C WB (60°F); temperatura exterior 35°C DB (95°F). Calefacción: temperatura interior 20°C DB (68°F), 15°C WB (44.6°F); temperatura exterior 7°C DB (42.8°F).

Test conditions Cooling: indoor temperature 27°C DB (80.6°F), 19°C WB (60°F); outdoor temperature 35°C DB (95°F). Heating: indoor temperature 20°C DB (68°F), 15°C WB (44.6°F); outdoor temperature 7°C DB (42.8°F).

ELFO VRF - UNIDADES INTERIORES INDOOR UNITS

CONDUCTO DE ALTA PRESIÓN ESTÁTICA

High static pressure ducted unit



La alta presión estática garantiza un gran caudal de aire, facilitando el diseño de conductos de grandes dimensiones. Adecuado para diferentes configuraciones de espacios y grandes superficies. Equipado con motor AC y filtro de aire. Válvula de expansión integrada. Bomba de drenaje de condensados opcional.

The high static pressure version ensures a large air flow, facilitating the design of large duct systems. Suitable for various room layouts and expansive areas. Equipped with an AC motor and air filter. Expansion valve on board. Optional condensate drain pump.

Unidad canalizada de alta presión estática - High static pressure unit

Código - Code		-	TPV-V71TH/HR1-B	TPV-V80TH/HR1-B	TPV-V90TH/HR1-B	TPV-V100TH/HR1-B	TPV-V120TH/HR1-B	TPV-V150TH/HR1-B	TPV-V200TH/HR1-B	TPV-V250TH/HR1-B
Alimentación - Power Supply		V-Hz-Ph	230-50-1	230-50-1	230-50-1	230-50-1	230-50-1	230-50-1	230-50-1	230-50-1
Refrigeración Cooling	Potencia Capacity	W/BTU	7100/24200	8000/27200	9000/30700	10000/34100	12000/40900	15000/51100	20000/68200	25000/85300
Calefacción Heating	Potencia Capacity	W/BTU	7800/26600	8800/30000	10000/34100	11000/37500	13000/44300	17000/58000	22000/75000	27500/93800
Caudal de aire - Air flow		m³/h	1500	1500	1500	2300	2300	2300	4000	4200
Presión sonora - Sound level		dB(A)	40~42	40~42	40~42	44~52	44~52	44~52	45~53	45~54
Potencia sonora - Sound power		dB(A)	51~53	51~53	51~53	55~63	55~63	55~63	56~64	56~65
Dimensiones - Dimensions (LxPxH)		mm	1445x260x680	1445x260x680	1445x260x680	1190x370x620	1190x370x620	1190x370x620	1465x448x811	1465x448x811
Peso - Weight		Kg	46	46	46	47	47	47	102	102
Tuberías frigoríficas Refrigeration piping	Dimensiones Dimensions	inch	3/8"-5/8"	3/8"-5/8"	3/8"-5/8"	3/8"-5/8"	3/8"-5/8"	3/8"-5/8"	1/2"-7/8"	1/2"-7/8"

CASSETTE DE 4 VÍAS

4-way cassette



Unidad interior tipo cassette de 4 vías, equipada con motor DC, regulación progresiva de la ventilación y filtro de aire. Válvula de expansión y bomba de drenaje de condensados integradas.

4-way cassette indoor unit, equipped with an DC motor, progressive fan speed control, and air filter. Expansion valve and condensate drain pump built-in.

Cassette de 4 vías compacta - 4 way cassette compact type

Código - Code		-	TPV-D22Q4/HR1-C	TPV-D28Q4/HR1-C	TPV-D36Q4/HR1-C	TPV-D45Q4/HR1-C
Alimentación - Power Supply		V-Hz-Ph	230-50-1	230-50-1	230-50-1	230-50-1
Refrigeración Cooling	Potencia Capacity	W/BTU	2200/7500	2800/9500	3600/12200	4500/15300
Calefacción Heating	Potencia Capacity	W/BTU	2500/8500	3200/10900	4000/13600	5000/17000
Caudal de aire - Air flow		m³/h	447	447	515	515
Presión sonora - Sound level		dB(A)	22~34	22~34	27~38	27~38
Potencia sonora - Sound power		dB(A)	33~45	33~45	38~49	38~49
Dimensiones - Dimensions (LxPxH)		mm	653x267x585	653x267x585	653x267x585	653x267x585
Peso - Weight		Kg	650x30x650	650x30x650	650x30x650	650x30x650
Tuberías frigoríficas Refrigeration piping	Dimensiones Dimensions	inch	17,5	17,5	17,5	17,5

Condiciones de prueba Refrigeración: temperatura interior 27°C DB (80.6°F), 19°C WB (60°F); temperatura exterior 35°C DB (95°F). Calefacción: temperatura interior 20°C DB (68°F), 15°C WB (44.6°F); temperatura exterior 7°C DB (42.8°F).

Test conditions Cooling: indoor temperature 27°C DB (80.6°F), 19°C WB (60°F); outdoor temperature 35°C DB (95°F). Heating: indoor temperature 20°C DB (68°F), 15°C WB (44.6°F); outdoor temperature 7°C DB (42.8°F).

ELFO VRF - UNIDADES INTERIORES INDOOR UNITS

LOS INVISIBLES
THE INVISIBLES

CASSETTE ROUND-FLOW

Round-flow cassette



Unidad interior tipo cassette con panel round-flow, equipada con motor DC, regulación progresiva de la ventilación y filtro de aire. Válvula de expansión y bomba de drenaje de condensados integradas.

The low static pressure version features compact dimensions, making it particularly suitable for installation in false ceilings. Equipped with a DC motor, progressive fan speed control, and air filter. Expansion valve built-in. Optional condensate drain pump.

Cassette Round Flow - Cassette Round flow				TPV-D56QR/HR1	TPV-D71QR/HR1	TPV-D80QR/HR1	TPV-D90QR/HR1	TPV-D100QR/HR1	TPV-D112QR/HR1	TPV-D125QR/HR1	TPV-D140QR/HR1	TPV-D160QR/HR1
Código - Code		-										
Alimentación - Power Supply		V-Hz-Ph		230-50-1	230-50-1	230-50-1	230-50-1	230-50-1	230-50-1	230-50-1	230-50-1	230-50-1
Refrigeración Cooling	Potencia Capacity	W/BTU	5600/19100	7100/24200	8000/27200	9000/30700	10000/34100	11200/38200	12500/42600	14000/47700	16000/54500	
Calefacción Heating	Potencia Capacity	W/BTU	6300/21400	8000/27200	8800/30000	10000/34100	11000/37500	12500/42600	14000/47700	15000/51100	17000/58000	
Caudal de aire - Air flow		m³/h	860	1200	1200	1400	1400	1400	1400	1800	1800	
Presión sonora - Sound level		dB(A)	32~39	35~39	35~39	37~41	37~41	37~41	37~41	38~42	38~42	
Potencia sonora - Sound power		dB(A)	43~50	46~50	46~50	48~52	48~52	48~52	48~52	49~53	49~53	
Dimensiones - Dimensions (LxPxH)		mm	833x232x900	833x232x900	833x232x900	833x232x900	833x286x900	833x286x900	833x286x900	833x286x900	833x286x900	833x286x900
Peso - Weight		Kg	950x50x950	950x50x950	950x50x950	950x50x950	950x50x950	950x50x950	950x50x950	950x50x950	950x50x950	950x50x950
Tuberías frigoríficas Refrigeration piping	Dimensiones Dimensions	inch	24	24	24	28,5	28,5	28,5	28,5	28,5	28,5	28,5

Condiciones de prueba Refrigeración: temperatura interior 27°C DB (80.6°F), 19°C WB (60°F); temperatura exterior 35°C DB (95°F). Calefacción: temperatura interior 20°C DB (68°F), 15°C WB (44.6°F); temperatura exterior 7°C DB (42.8°F).

Test conditions Cooling: indoor temperature 27°C DB (80.6°F), 19°C WB (60°F); outdoor temperature 35°C DB (95°F). Heating: indoor temperature 20°C DB (68°F), 15°C WB (44.6°F); outdoor temperature 7°C DB (42.8°F).

COMBINACIONES SOPORTADAS

Supported Combinations

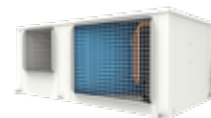

ELFO VRF			
	Capacidad mín UI - IU Min capacity	Capacidad Max UI - IU Max capacity	Nº UI max - Max IU N°
ELFO-35H	7,0 kW	13,0 kW	5
ELFO-48H	9,8 kW	18,2 kW	8
ELFO-55H	11,2 kW	20,9 kW	9
ELFO-76H	15,7 kW	31,2 kW	13

N.B.

- 1- En caso de funcionamiento simultáneo de las unidades interiores, la potencia máxima suministrada no puede superar la de la unidad condensadora.
1- In the case of contemporaneity in the use of indoor units, the maximum power delivered can not be higher than that of the condensing unit.
- 2- La capacidad total de las unidades interiores instalables debe estar comprendida entre el 70% y el 130% de la capacidad de la unidad condensadora.
2- The total capacity of the installable indoor units must be between 70% and 130% of the capacity of the condensing unit.



IDRA - el climatizador invisible con condensación por agua, diseñado para instalarse en el interior de la vivienda (bajo el fregadero, en un mueble de baño o en un espacio técnico), eliminando completamente el impacto visual de las unidades exteriores.

Disponible en configuración mono, dual, trial y quadri split, IDRA se distingue por:

- tecnología Full DC Inverter con compresores Panasonic y Mitsubishi;
- funcionamiento silencioso;
- clase energética A++;
- instalación compacta y discreta;
- posibilidad de funcionamiento con agua a pérdida o en sistema de circuito en anillo.

Gracias a una constante inversión en investigación y desarrollo, Tekno Point ha optimizado progresivamente el uso del agua en los sistemas IDRA.



IDRA the water-cooled invisible air conditioner, designed for indoor installation (under the sink, inside a bathroom cabinet, or in a technical room), completely eliminating the visual impact of outdoor units. Available in mono, dual, trial, and quad split configurations, IDRA stands out for:

- Full DC Inverter technology with Panasonic and Mitsubishi compressors;
- Quiet operation;
- A++ energy efficiency rating;
- Compact and discreet installation;
- The option to operate with once-through water or on a closed-loop system.

Through continuous investment in research and development, Tekno Point has progressively optimized water consumption in IDRA systems.

Para obtener un alto rendimiento y un consumo reducido, los climatizadores invisibles Tekno Point utilizan compresores y componentes electrónicos de los mejores fabricantes.

To achieve high performance and low energy consumption, Tekno Point Invisible air conditioners use compressors and electronics from the best manufacturers.

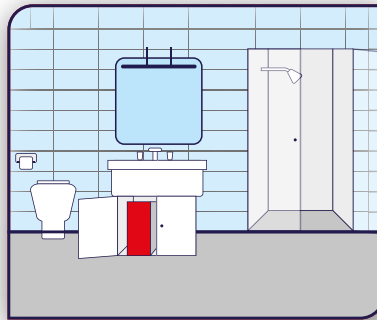

Instalación en un mueble de baño
Installation in a bathroom cabinet

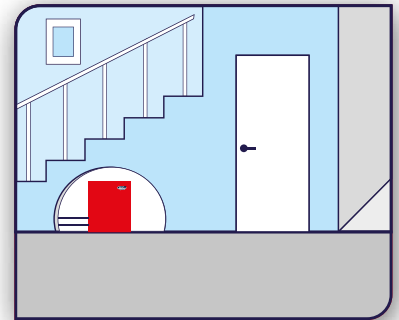

Instalación en espacio bajo la escalera
Installation in a cupboard

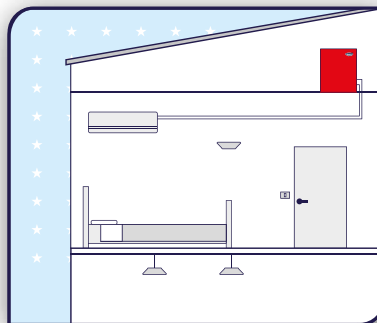

Instalación en el falso techo
Installation in the attic

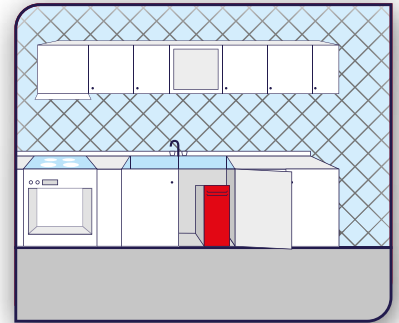

Instalación debajo del fregadero de cocina
Installation under kitchen sink

Clasificación energética de los climatizadores agua-aire

Energy classification of water-air conditioners

	EER		COP
A+++	≥ 8,50	A+++	≥ 5,10
A++	≥ 6,10	A++	≥ 4,60
A+	≥ 5,10	A+	≥ 4,00
B	≥ 4,60	B	≥ 3,10
C	≥ 4,10	C	≥ 2,80
D	≥ 3,60	D	≥ 2,50
E	≥ 3,10	E	≥ 2,20
F	≥ 2,60	F	≥ 1,90
G	≥ 2,60	G	> 1,90

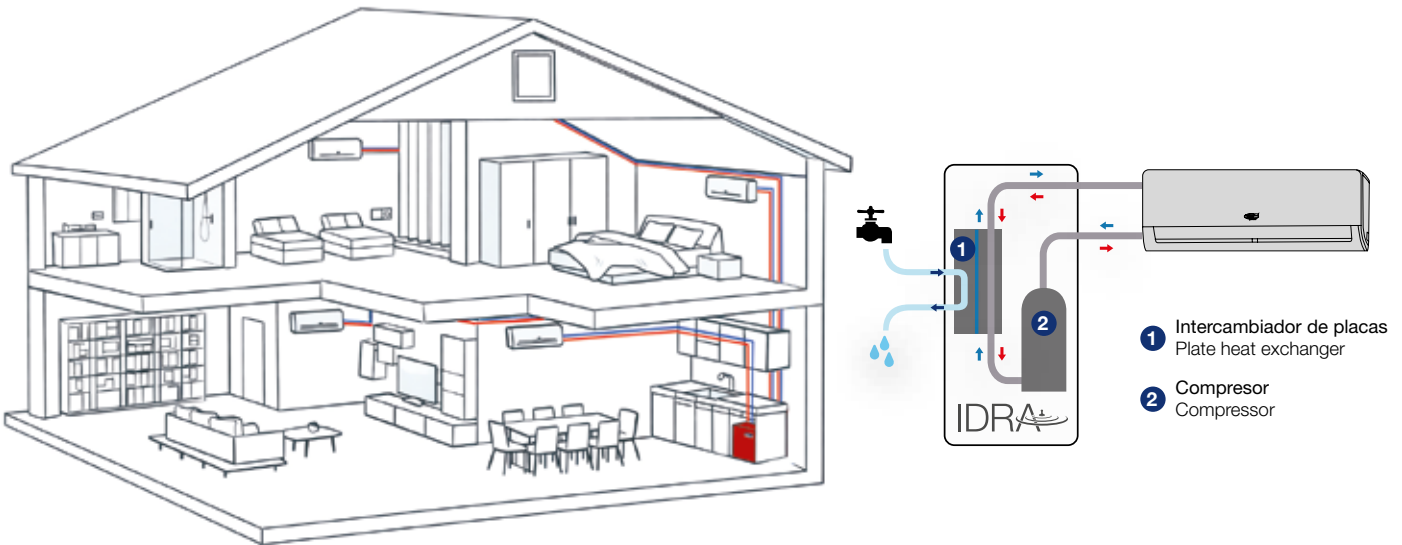



IDRA next

IDRA eco

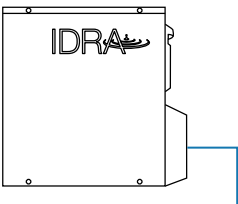
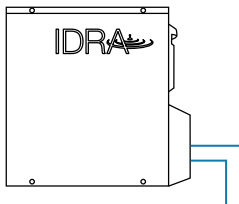
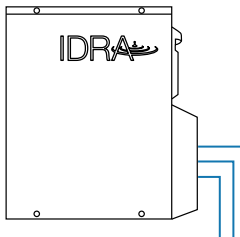
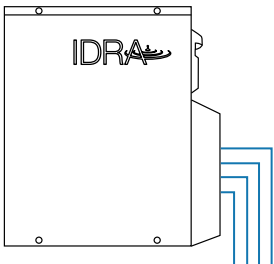
IDRA ring

monosplit	dual split	trial split	quadri split
			
12.000 BTU - 3,5 kW 18.000 BTU - 5,2 kW 24.000 BTU - 7,0 kW 36.000 BTU - 10,5 kW	18.000 BTU - 5,5 kW	24.000 BTU - 7,4 kW	28.000 BTU - 8,5 kW 36.000 BTU - 10,5 kW

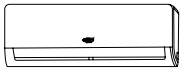
Elige la unidad interior compatible - Choose indoor units that can be matched

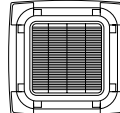
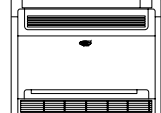
			
SPLIT WALL MOUNTED	CANALIZADO DUCT UNIT	CASSETTE CASSETTE	CONSOLA CONSOLLE



🇪🇸
 Invisible, silencioso y compacto, el climatizador condensado por agua que garantiza altas prestaciones y un bajo consumo energético con CERO IMPACTO estético. Se instala fácilmente dentro de un mueble bajo el fregadero, en el baño o en cualquier espacio reducido. Equipado con tecnología Full DC Inverter, garantiza un excelente rendimiento tanto en modo refrigeración como en calefacción.

🇬🇧
 Invisible, silent and compact, the **water-cooled air conditioner** guarantees high performance and low energy consumption with an aesthetic ZERO IMPACT. It is easily installed inside a cabinet under the sink, in the bathroom or in any small space. Equipped with Full DC inverter technology, it guarantees excellent performance both in cooling and in heating mode.

IDRA^{next} MONOSPLIT

UNIDAD CONDENSADORA OCULTA DC INVERTER INVISIBLE CONDENSING UNIT DC INVERTER

Apto para su uso en salas de servidores (CPD) para la disipación del calor tanto en el período estival como invernal.
 Suitable for use in server rooms for heat dissipation in summer and winter.



IDRA-12 | IDRA-18



IDRA-24 | IDRA-36

IDRA 12.000 BTU - 3,5 kW
IDRA 18.000 BTU - 5,2 kW
IDRA 24.000 BTU - 7,0 kW
IDRA 36.000 BTU - 10,5 kW
 combinable - combined with:

Split mural
 Wall mounted
SKIV
IMAGINE



Canalizados
 Duct unit
DUCT-V
DBIS PLUS



Cassette de 4 vías
 Cassette
CASK-CV
CASK-V



Consola
 Console
CNS



Datos técnicos y descripciones disponibles en la sección "**Unidades interiores ELFO e IDRA**".
 Technical data and descriptions available in the "ELFO and IDRA Indoor Units" section.

Sólo frío - Cooling only

Bomba de calor - Heat Pump

- IDRA-12C**
- IDRA-24C**
- IDRA-18C**
- IDRA-36C**

- IDRA-12H**
- IDRA-24H**
- IDRA-18H**
- IDRA-36H**

Design Made in Italy

IDRA NEXT MONOSPLIT

CLIMATIZADOR INVISIBLE AGUA-AIRE

WATER-AIR INVISIBLE AIR CONDITIONER



LOS INVISIBLES
THE INVISIBLES

¡El menor consumo de agua de su categoría!
The lowest water usage in the category!

IDRA Monosplit DC inverter				Cod.	IDRA-12C	IDRA-18C	IDRA-24C	IDRA-36C
Sólo frío - Only Cooling				Cod.	IDRA-12H	IDRA-18H	IDRA-24H	IDRA-36H
Bomba de calor - Heat Pump				Cod.	IDRA-12H	IDRA-18H	IDRA-24H	IDRA-36H
Alimentación - Power Supply				V-Hz-Ph	230-50-1	230-50-1	230-50-1	230-50-1
Protección contra sobrecorriente - Max Overcurrent Protection				A	16	25	25	25,0
Sección cables alimentación - Power cable cross-sectional area				mm ²	3 x 1,5	3 x 2,5	3 x 2,5	3 x 4,0
Refrigeración Cooling	Potencia Capacity	Nominal	W/BTU	3500/12000	5200/17742	7000/23884	10500/35826	
		Min/Max	W	1500/4100	2100/5900	2300/7800	3100/12100	
	Consumo eléctrico Max power absorbtion	Nominal	W	800	1200	1730	2080	
		Min/Max	W	280/1310	360/1790	650/2100	750/4100	
EER			W/W	4,38	4,33	4,05	5,05	
Clase energética - Energy class				-	A++	A++	A++	A++
Calefacción Heating	Potencia Capacity	Nominal	W/BTU	3500/12000	5200/17742	7000/23884	10500/35805	
		Min/Max	W	1500/3900	2550/5950	2300/7800	3100/11600	
	Consumo eléctrico Max power absorbtion	Nominal	W	880	1290	1790	2260	
		Min/Max	W	290/1220	350/1820	650/2100	750/3900	
COP			W/W	3,98	4,03	3,92	4,64	
Clase energética - Energy class				-	A+	A+	A+	A+
Presión sonora - Sound level				dB(A)	41	42	42	44
Potencia sonora - Sound power				dB(A)	51	52	52	54
Método de regulación - Throttling method				-	EEV	EEV	EEV	EEV
Dimensiones - Dimensions (LxPxH)				mm	470 x 300 x 480	500 x 300 x 530	500 x 300 x 530	500 x 300 x 670
Peso - Weight				Kg	33	34	37	42
Compresor - Compressor				-	Panasonic	Panasonic	Panasonic	Mitsubishi
Refrigerante Refrigerant	Tipo - Type			-	R32	R32	R32	R32
	Precarga - Precharge			Kg	0,75	1,10	1,30	2,10
	Carga adicional - Add. Charge			gr/m	22	22	22	22
Tuberías frigoríficas Refrigeration pipes	Dimensiones - Dimensions			Inch	1/4" - 3/8"	1/4" - 1/2"	1/4" - 5/8"	3/8" - 5/8"
	Distancia máxima con precarga Max distance with pre-charge			m	7,5	10	10	10
	Distancia máxima admisible entre U.I. y U.E. Max allowable distance between IU and OU			m	15	20	30	40
	Desnivel máximo admisible entre U.I. y U.E. Max elevation difference between IU and OU			m	5	5	5	5
Conexiones de agua - Water connections				Inch	1/2"	1/2"	1/2"	1/2"
Presión óptima del agua de entrada - Optimal inlet water pressure				bar	1,5 - 2,0	1,5 - 2,0	1,5 - 2,0	1,5 - 2,0
Consumo de agua - Use of water	Refrigeración - Cooling			m ³ /h	0,06 / 0,13	0,07 / 0,18	0,07 / 0,27	0,12 / 0,43
	Calefacción - Heating			m ³ /h	0,08 / 0,17	0,09 / 0,30	0,09 / 0,44	0,15 / 0,61
Temperatura ajustable Set temperature range				°C	+16~+31	+16~+31	+16~+31	+16~+31
Límites de funcionamiento* Operating limits*				°C	+12 / +25	+12 / +25	+12 / +25	+12 / +25

N.B.: la normativa no contempla SEER y SCOP para las unidades agua-aire | The regulations do not require SEER and SCOP for water-to-air units.

Condiciones de prueba IDRA Refrigeración: agua entrada/salida 15/40 °C
Calefacción: agua entrada/salida 15/4 °C.
Condiciones de prueba unidad interior Refrigeración: unidad interior 27 °C
B.S. Calefacción: unidad interior 20 °C B.S.

IDRA test conditions Cooling: water inlet/outlet 15/40°C
Heating: water inlet/outlet 15/4°C
Indoor unit test conditions Cooling: indoor unit 27°C D.B.
Heating: indoor unit 20°C D.B.

* Para agua de entrada con temperatura comprendida entre 7 °C y 12 °C es necesario utilizar el "KIT BT IDRA".

* For incoming water with a temperature between 7°C and 12°C, it is necessary to use the "KIT BT IDRA."



Sistema de climatización condensado por agua con altas prestaciones y bajo consumo energético, con **CERO IMPACTO estético**. Se instala fácilmente dentro de un mueble, bajo el fregadero o en cualquier espacio reducido. Con tecnología Full DC Inverter, garantiza un excelente rendimiento tanto en modo refrigeración como en calefacción. Disponible en versiones dual, trial y cuádruple split. Compatible con todas las unidades interiores.



Water-cooled air conditioning system with ZERO aesthetic IMPACT that guarantees high efficiency and low energy consumption. It is easily installed inside a cabinet, under the sink or in any small space. Full DC inverter technology, ensure high performance in both cooling and heating mode. Available in dual, trial and quadri split versions. Can be combined with each type of indoor units.

IDRA^{next} MULTISPLIT

UNIDAD CONDENSADORA OCULTA DC INVERTER INVISIBLE CONDENSING UNIT DC INVERTER

El menor consumo de agua de su categoría!
The lowest water usage in the category!



IDRA2-18



IDRA3-24



IDRA4-28 | IDRA4-36

IDRA2 18.000 BTU - 5,2 kW
IDRA3 24.000 BTU - 7,0 kW
IDRA4 28.000 BTU - 8,2 kW
IDRA4 36.000 BTU - 10,5 kW
combinable - combined with:

Split mural
Wall mounted
SKIV
IMAGINE



Canalizados
Duct unit
DUCT-V
DBIS PLUS



Cassette de 4 vías
Cassette
CASK-CV
CASK-V



Consola
Console
CNS



Datos técnicos y descripciones disponibles en la sección **"Unidades interiores ELFO e IDRA"**.
Technical data and descriptions available in the "ELFO and IDRA Indoor Units" section.

Sólo frío - Cooling only

IDRA2-18C

IDRA3-24C

IDRA4-28C

IDRA4-36C

Bomba de calor - Heat Pump

IDRA2-18H

IDRA3-24H

IDRA4-28H

IDRA4-36H

Design Made in Italy

IDRA NEXT MULTISPLIT

CLIMATIZADOR INVISIBLE AGUA-AIRE

WATER-AIR INVISIBLE AIR CONDITIONER



LOS INVISIBLES
THE INVISIBLES

IDRA Multisplit DC inverter							
Sólo frío - Only Cooling			Cod.	IDRA2-18C	IDRA3-24C	IDRA4-28C	IDRA4-36C
Bomba de calor - Heat Pump			Cod.	IDRA2-18H	IDRA3-24H	IDRA4-28H	IDRA4-36H
Alimentación - Power Supply			V-Hz-Ph	230-50-1	230-50-1	230-50-1	230-50-1
Protección contra sobrecorriente - Max Overcurrent Protection			A	25	25	25	25
Sección cables alimentación - Power cable cross-sectional area			mm ²	3 x 2,5	3 x 2,5	3 x 4,0	3 x 4,0
Refrigeración Cooling	Potencia Capacity	Nominal	W/BTU	5200/17742	7000/23884	8200/28000	10500/35826
		Min/Max	W	2100/5900	2300/7800	2300/9100	3100/12100
	Consumo eléctrico Max power absorbtion	Nominal	W	1220	1740	2070	2100
		Min/Max	W	360/1790	650/2100	650/2900	650/4100
EER			W/W	4,26	4,02	3,96	4,92
Clase energética - Energy class			-	A++	A++	A++	A++
Calefacción Heating	Potencia Capacity	Nominal	W/BTU	5200/17742	7000/23884	8200/28000	10500/35826
		Min/Max	W	2550/5950	2300/7800	2300/8900	3100/12100
	Consumo eléctrico Max power absorbtion	Nominal	W	1290	1800	2100	2630
		Min/Max	W	350/1820	650/2100	650/2700	650/3900
COP			W/W	4,03	3,89	3,91	4,00
Clase energética - Energy class			-	A+	A+	A+	A+
Presión sonora - Sound level			dB(A)	42	42	42	44
Potencia sonora - Sound power			dB(A)	52	52	52	54
Método de regulación - Throttling method			-	EEV	EEV	EEV	EEV
Dimensiones - Dimensions (LxPxH)			mm	500 x 300 x 530	500 x 300 x 670	500 x 300 x 750	500 x 300 x 750
Peso - Weight			Kg	35	38	40	40
Compresor - Compressor			-	Panasonic	Panasonic	Panasonic	Mitsubishi
Refrigerante Refrigerant	Tipo - Type		-	R32	R32	R32	R32
	Precarga - Precharge		Kg	1,1	1,30	1,50	1,90
	Carga adicional - Add. Charge		gr/m	22	22	22	22
Tuberías frigoríficas Refrigeration pipes	Dimensiones - Dimensions		Inch	1/4" - 3/8" x2	1/4" - 3/8" x3	1/4" - 3/8" x4	1/4" - 3/8" x2 1/4" - 1/2" x2
	Distancia máxima con precarga Max distance with pre-charge		m	10	10	20	20
	Distancia máxima admisible entre U.I. y U.E. Max allowable distance between IU and OU		m	10 / 20	10 / 30	10 / 40	10 / 40
	Desnivel máximo admisible entre U.I. y U.E. Max elevation difference between IU and OU		m	5	5	5	5
Conexiones de agua - Water connections			Inch	1/2"	1/2"	1/2"	1/2"
Presión óptima del agua de entrada - Optimal inlet water pressure			bar	1,5 - 2,0	1,5 - 2,0	1,5 - 2,0	1,5 - 2,0
Consumo de agua Use of water	Refrigeración - Cooling		m ³ /h	0,07 / 0,18	0,07 / 0,27	0,07 / 0,32	0,12 / 0,44
	Calefacción - Heating		m ³ /h	0,09 / 0,30	0,09 / 0,44	0,09 / 0,50	0,15 / 0,65
Temperatura ajustable Set temperature range	Unidad interior - Indoor Unit		°C	+16~+31	+16~+31	+16~+31	+16~+31
Límites de funcionamiento* Operating limits*	Agua de entrada MIN Calef. / MÁX Refrig Inlet Water MIN Heating / MAX cooling		°C	+12 / +25	+12 / +25	+12 / +25	+12 / +25

N.B.: la normativa no contempla SEER y SCOP para las unidades agua-aire | The regulations do not require SEER and SCOP for water-to-air units.

Condiciones de prueba IDRA Refrigeración: agua entrada/salida 15/40 °C
Calefacción: agua entrada/salida 15/4 °C.

Condiciones de prueba unidad interior Refrigeración: unidad interior 27 °C
B.S. Calefacción: unidad interior 20 °C B.S.

* Para agua de entrada con temperatura comprendida entre 7 °C y 12 °C es necesario utilizar el "KIT BT IDRA".

Testing conditions for IDRA Cooling: water inlet/outlet 15/40°C
Heating: water inlet/outlet 15/4°C

Testing conditions for indoor unit: Cooling: indoor unit at 27°C D.B.
Heating: indoor unit at 20°C D.B.

* For incoming water with a temperature between 7°C and 12°C, it is necessary to use the "KIT BT IDRA."



Invisible, silencioso y compacto, el climatizador condensado por agua que garantiza altas prestaciones y un bajo consumo energético con CERO IMPACTO estético. Se instala fácilmente dentro de un mueble bajo el fregadero, en el baño o en cualquier espacio reducido. El nuevo IDRA ECO es la elección obligada para quienes buscan el confort climático unido a un consumo de energía muy bajo.



Invisible, silent and compact, the **water-cooled air conditioner** that guarantees high performance and low energy consumption with ZERO aesthetic IMPACT. It can be easily installed inside a piece of furniture under the sink, in the bathroom or in any small space. The new IDRA ECO is the obligatory choice for those who choose climate comfort combined with a **very low energy consumption**.

IDRA_{eco} MONOSPLIT

eco

UNIDAD CONDENSADORA OCULTA DE AHORRO ENERGÉTICO ENERGY SAVING INVISIBLE CONDENSING UNIT

Alto rendimiento + Bajo consumo eléctrico
High performance + Reduced use of electricity power



IDRA-E12 | IDRA-E18



IDRA-E24 | IDRA-E36

IDRA E 12.000 BTU - 3,5 kW
IDRA E 18.000 BTU - 5,2 kW
IDRA E 24.000 BTU - 7,0 kW
IDRA E 36.000 BTU - 10,5 kW
combinable - combined with:

Split mural
Wall mounted
**SKIV
IMAGINE**



Canalizados
Duct unit
**DUCT-V
DBIS PLUS**



Cassette de 4 vías
Cassette
**CASK-CV
CASK-V**



Consola
Console
CNS



Datos técnicos y descripciones disponibles en la sección "**Unidades interiores ELFO e IDRA**".
Technical data and descriptions available in the "ELFO and IDRA Indoor Units" section.

Sólo frío - Cooling only

IDRA-E12C

IDRA-E24C

IDRA-E18C

IDRA-E36C

Bomba de calor - Heat Pump

IDRA-E12H

IDRA-E24H

IDRA-E18H

IDRA-E36H

Design Made in Italy

IDRA ECO MONOSPLIT

CLIMATIZADOR INVISIBLE AGUA-AIRE

INVISIBLE WATER COOLED CONDENSING UNIT

eco



LOS INVISIBLES
THE INVISIBLES

IDRA ECO Monosplit DC inverter				Cod.	IDRA-E12C	IDRA-E18C	IDRA-E24C	IDRA-E36C
Sólo frío - Only Cooling				Cod.	IDRA-E12H	IDRA-E18H	IDRA-E24H	IDRA-E36H
Alimentación - Power Supply				V-Hz-Ph	230-50-1	230-50-1	230-50-1	230-50-1
Protección contra sobrecorriente - Max Overcurrent Protection				A	16	25	25	25,0
Sección cables alimentación - Power cable cross-sectional area				mm ²	3 x 1,5	3 x 2,5	3 x 2,5	3 x 4,0
Refrigeración Cooling	Potencia Capacity	Nominal	W/BTU	3500/12000	5200/17742	7000/23884	10500/35826	
		Min/Max	W	1500/4100	2100/5900	2300/7800	3100/12100	
	Consumo eléctrico Max power absorbtion	Nominal	W	690	1030	1440	1820	
		Min/Max	W	280/1310	360/1790	650/2100	750/4100	
EER		W/W		5,09	5,05	4,87	5,75	
Clase energética - Energy class				-	A+++	A+++	A+++	A+++
Calefacción Heating	Potencia Capacity	Nominal	W/BTU	3500/12000	5200/17742	7000/23884	10500/35805	
		Min/Max	W	1500/3900	2550/5950	2300/7800	3100/11600	
	Consumo eléctrico Max power absorbtion	Nominal	W	720	1080	1510	1920	
		Min/Max	W	290/1220	350/1820	650/2100	750/3900	
COP		W/W		4,86	4,81	4,64	5,45	
Clase energética - Energy class				-	A++	A++	A++	A++
Presión sonora - Sound level				dB(A)	41	42	42	44
Potencia sonora - Sound power				dB(A)	51	52	52	54
Método de regulación - Throttling method				-	EEV	EEV	EEV	EEV
Dimensiones - Dimensions (LxPxH)				mm	470 x 300 x 480	500 x 300 x 530	500 x 300 x 530	500 x 300 x 670
Peso - Weight				Kg	33	34	37	42
Compresor - Compressor				-	Panasonic	Panasonic	Panasonic	Mitsubishi
Refrigerante Refrigerant	Tipo - Type			-	R32	R32	R32	R32
	Precarga - Precharge			Kg	0,75	1,10	1,30	1,80
	Carga adicional - Add. Charge			gr/m	22	22	22	22
Tuberías frigoríficas Refrigeration pipes	Dimensiones - Dimensions			Inch	1/4" - 3/8"	1/4" - 1/2"	1/4" - 5/8"	3/8" - 5/8"
	Distancia máxima con precarga Max distance with pre-charge			m	7,5	10	10	10
	Distancia máxima admisible entre U.I. y U.E. Max allowable distance between IU and OU			m	15	20	30	40
	Desnivel máximo admisible entre U.I. y U.E. Max elevation difference between IU and OU			m	5	5	5	5
Conexiones de agua - Water connections				Inch	1/2"	1/2"	1/2"	1/2"
Presión óptima del agua de entrada - Optimal inlet water pressure				bar	1,5 - 2,0	1,5 - 2,0	1,5 - 2,0	1,5 - 2,0
Consumo de agua Use of water Potencia - Capacity 15% / 100%	Refrigeración - Cooling			m ³ /h	0,06 / 0,21	0,07 / 0,28	0,07 / 0,42	0,12 / 0,69
	Calefacción - Heating			m ³ /h	0,08 / 0,53	0,09 / 0,95	0,09 / 1,37	0,15 / 1,69
Temperatura ajustable Set temperature range	Unidad interior - Indoor Unit			°C	+16~+31	+16~+31	+16~+31	+16~+31
Límites de funcionamiento* Operating limits*	Agua de entrada MÍN Calef. / MÁX Refrig Inlet Water MIN Heating / MAX cooling			°C	+12 / +25	+12 / +25	+12 / +25	+12 / +25

N.B.: la normativa no contempla SEER y SCOP para las unidades agua-aire | The regulations do not require SEER and SCOP for water-to-air units.

Condiciones de prueba IDRA Refrigeración: agua entrada/salida 15/30 °C
Calefacción: agua entrada/salida 10/7 °C.

Condiciones de prueba unidad interior: Refrigeración: unidad interior 27 °C B.S.
Calefacción: unidad interior 20 °C B.S.

* Para agua de entrada con temperatura comprendida entre 7 °C y 12 °C es necesario utilizar el "KIT BT IDRA".

Testing conditions for IDRA Cooling: water inlet/outlet 15/30°C
Heating: water inlet/outlet 10/7°C.

Testing conditions for indoor unit: Cooling: indoor unit at 27°C D.B.
Heating: indoor unit at 20°C D.B.

* For incoming water with a temperature between 7°C and 12°C, it is necessary to use the "KIT BT IDRA."



 Invisible, silencioso y compacto, el climatizador condensado por agua que garantiza altas prestaciones y un bajo consumo energético con CERO IMPACTO estético. Se instala fácilmente dentro de un mueble bajo el fregadero, en el baño o en cualquier espacio reducido. El nuevo IDRA ECO es la elección obligada para quienes buscan el confort climático unido a un consumo de energía muy bajo.

 Invisible, silent and compact, the water-cooled air conditioner that guarantees high performance and low energy consumption with ZERO aesthetic IMPACT. It can be easily installed inside a piece of furniture under the sink, in the bathroom or in any small space. The new IDRA ECO is the obligatory choice for those who choose climate comfort combined with a very low energy consumption.

IDRA_{eco} MULTISPLIT

eco

UNIDAD MOTOCONDENSADORA OCULTA DE AHORRO ENERGÉTICO
ENERGY SAVING INVISIBLE CONDENSING UNIT



IDRA2-E18



IDRA3-E24



IDRA4-E28 | IDRA4-E36

IDRA2 E 18.000 BTU - 5,2 kW
IDRA3 E 24.000 BTU - 7,0 kW
IDRA4 E 28.000 BTU - 8,2 kW
IDRA4 E 36.000 BTU - 10,5 kW
combinable - combined with:

Split mural
Wall mounted
SKIV
IMAGINE



Canalizados
Duct unit
DUCT-V
DBIS PLUS



Cassette de 4 vías
Cassette
CASK-CV
CASK-V



Consola
Console
CNS



Datos técnicos y descripciones disponibles en la sección **"Unidades interiores ELFO e IDRA"**.
Technical data and descriptions available in the "ELFO and IDRA Indoor Units" section.

Sólo frío - Cooling only

IDRA2-E18C

IDRA3-E24C

IDRA4-E28C

IDRA4-E36C

Bomba de calor - Heat Pump

IDRA2-E18H

IDRA3-E24H

IDRA4-E28H

IDRA4-E36H

Design Made in Italy

IDRA ECO MULTISPLIT

CLIMATIZADOR INVISIBLE AGUA-AIRE

INVISIBLE WATER COOLED CONDENSING UNIT

eco



LOS INVISIBLES
THE INVISIBLES

IDRA ECO Multisplit DC inverter							
Sólo frío - Only Cooling			Cod.	IDRA2-E18C	IDRA3-E24C	IDRA4-E28C	IDRA4-E36C
Bomba de calor - Heat Pump			Cod.	IDRA2-E18H	IDRA3-E24H	IDRA4-E28H	IDRA4-E36H
Alimentación - Power Supply			V-Hz-Ph	230-50-1	230-50-1	230-50-1	230-50-1
Protección contra sobrecorriente - Max Overcurrent Protection			A	25	25	25	25
Sección cables alimentación - Power cable cross-sectional area			mm ²	3 x 2,5	3 x 2,5	3 x 4,0	3 x 4,0
Refrigeración Cooling	Potencia Capacity	Nominal	W/BTU	5200/17742	7000/23884	8200/28000	10500/35826
		Min/Max	W	2100/5900	2300/7800	2300/9100	3100/12100
	Consumo eléctrico Max power absorbtion	Nominal	W	1040	1440	1700	1970
		Min/Max	W	360/1790	650/2100	650/2900	750/4100
EER			W/W	4,98	4,85	4,81	5,32
Clase energética - Energy class			-	A+++	A+++	A+++	A+++
Calefacción Heating	Potencia Capacity	Nominal	W/BTU	5200/17742	7000/23884	8200/28000	10500/35826
		Min/Max	W	2550/5950	2300/7800	2300/8900	3100/12100
	Consumo eléctrico Max power absorbtion	Nominal	W	1100	1540	1810	2070
		Min/Max	W	350/1820	650/2100	650/2700	750/3900
COP			W/W	4,73	4,55	4,53	5,07
Clase energética - Energy class			-	A++	A++	A++	A++
Presión sonora - Sound level			dB(A)	42	42	42	44
Potencia sonora - Sound power			dB(A)	52	52	52	54
Método de regulación - Throttling method			-	EEV	EEV	EEV	EEV
Dimensiones - Dimensions (LxPxH)			mm	500 x 300 x 530	500 x 300 x 670	500 x 300 x 750	500 x 300 x 750
Peso - Weight			Kg	35	38	40	42
Compresor - Compressor			-	Panasonic	Panasonic	Panasonic	Mitsubishi
Refrigerante Refrigerant	Tipo - Type		-	R32	R32	R32	R32
	Precarga - Precharge		Kg	1,10	1,30	1,50	1,90
	Carga adicional - Add. Charge		gr/m	22	22	22	22
Tuberías frigoríficas Refrigeration pipes	Dimensiones - Dimensions		Inch	1/4" - 3/8" x2	1/4" - 3/8" x3	1/4" - 3/8" x4	1/4" - 3/8" x2 1/4" - 1/2" x2
	Distancia máxima con precarga Max distance with pre-charge		m	10	10	20	20
	Distancia máxima admisible entre U.I. y U.E. Max allowable distance between IU and OU		m	10 / 20	10 / 30	10 / 40	10 / 40
	Desnivel máximo admisible entre U.I. y U.E. Max elevation difference between IU and OU		m	5	5	5	5
Conexiones de agua - Water connections			Inch	1/2"	1/2"	1/2"	1/2"
Presión óptima del agua de entrada - Optimal inlet water pressure			bar	1,5 - 2,0	1,5 - 2,0	1,5 - 2,0	1,5 - 2,0
Consumo de agua Use of water	Refrigeración - Cooling		m ³ /h	0,07 / 0,28	0,07 / 0,42	0,07 / 0,47	0,12 / 0,72
	Calefacción - Heating		m ³ /h	0,09 / 0,95	0,09 / 1,37	0,09 / 1,58	0,15 / 1,69
Temperatura ajustable Set temperature range	Unidad interior - Indoor Unit		°C	+16~+31	+16~+31	+16~+31	+16~+31
Límites de funcionamiento* Operating limits*	Agua de entrada MIN Calef. / MÁX Refrig Inlet Water MIN Heating / MAX cooling		°C	+12 / +25	+12 / +25	+12 / +25	+12 / +25

N.B.: la normativa no contempla SEER y SCOP para las unidades agua-aire | The regulations do not require SEER and SCOP for water-to-air units.

Condiciones de prueba IDRA Refrigeración: agua entrada/salida 15/30 °C
Calefacción: agua entrada/salida 10/7 °C.

Condiciones de prueba unidad interior: Refrigeración: unidad interior 27 °C B.S.
 Calefacción: unidad interior 20 °C B.S.

* Para agua de entrada con temperatura comprendida entre 7 °C y 12 °C es necesario utilizar el "KIT BT IDRA".

Testing conditions for IDRA Cooling: water inlet/outlet 15/30°C
Heating: water inlet/outlet 10/7°C.

Testing conditions for indoor unit: Cooling: indoor unit at 27°C D.B.
 Heating: indoor unit at 20°C D.B.

* For incoming water with a temperature between 7°C and 12°C, it is necessary to use the "KIT BT IDRA."



La versión RING de IDRA se beneficia de todas las ventajas de la condensadora de agua invisible y de la elección personalizada de cada unidad interior, combinadas con la conexión al circuito hidráulico de climatización presente en los edificios comerciales más modernos.

The RING version of IDRA benefits from all the advantages of the invisible water-cooled condenser and the customised choice of each indoor unit combined with the connection to the hydronic circuit for air conditioning found in most modern commercial buildings.

IDRA_{ring} MONOSPLIT

UNIDAD CONDENSADORA OCULTA PARA ANILLO DE AGUA
INVISIBLE CONDENSING UNIT FOR WATER LOOP



IDRA-R12 | IDRA-R18



IDRA-R24



IDRA-R36

IDRA R 12.000 BTU - 3,5 kW
IDRA R 18.000 BTU - 5,2 kW
IDRA R 24.000 BTU - 7,0 kW
IDRA R 36.000 BTU - 10,5 kW
combinable - combined with:

Split mural
Wall mounted
SKIV
IMAGINE



Canalizados
Duct unit
DUCT-V
DBIS PLUS



Cassette de 4 vías
Cassette
CASK-CV
CASK-V



Consola
Console
CNS



La circulación en la IDRA RING debe ser garantizada por el gestor del anillo. Datos técnicos y descripciones disponibles en la sección "Unidades interiores ELFO e IDRA".
Circulation in the IDRA RING must be guaranteed by the ring operator. Technical data and descriptions available in the "ELFO and IDRA Indoor Units" section.

Sólo frío - Cooling only

IDRA-R12C **IDRA-R24C**
IDRA-R18C **IDRA-R36C**

Bomba de calor - Heat Pump

IDRA-R12H **IDRA-R24H**
IDRA-R18H **IDRA-R36H**

Design Made in Italy

IDRA RING MONOSPLIT

UNIDAD CONDENSADORA OCULTA PARA ANILLO DE AGUA

INVISIBLE CONDENSING UNIT FOR WATER LOOP



LOS INVISIBLES
THE INVISIBLES

IDRA RING Monosplit DC inverter							
Sólo frío - Only Cooling		Cod.	IDRA-R12C	IDRA-R18C	IDRA-R24C	IDRA-R36C	
Bomba de calor - Heat Pump		Cod.	IDRA-R12H	IDRA-R18H	IDRA-R24H	IDRA-R36H	
Alimentación - Power Supply		V-Hz-Ph	230-50-1	230-50-1	230-50-1	230-50-1	
Protección contra sobrecorriente - Max Overcurrent Protection		A	16	25	25	25,0	
Sección cables alimentación - Power cable cross-sectional area		mm ²	3 x 1,5	3 x 2,5	3 x 2,5	3 x 4,0	
Refrigeración Cooling	Potencia Capacity	Nominal	W/BTU	3500/12000	5200/17742	7000/23884	10500/35805
		Min/Max	W	1500/4100	2100/5900	2300/7800	3100/12100
	Consumo eléctrico Max power absorbtion	Nominal	W	760	1130	1560	2280
		Min/Max	W	280/1310	360/1790	650/2100	750/4100
EER	W/W	4,64	4,62	4,49	4,61		
Clase energética - Energy class		-	A++	A++	A++	A++	
Calefacción Heating	Potencia Capacity	Nominal	W/BTU	3500/12000	5200/17742	7000/23884	10500/35805
		Min/Max	W	1500/3900	2550/5950	2300/7800	3100/11600
	Consumo eléctrico Max power absorbtion	Nominal	W	760	1130	1590	2100
		Min/Max	W	290/1220	350/1820	650/2100	750/3900
COP	W/W	4,56	4,61	4,41	5,07		
Clase energética - Energy class		-	A+	A+	A+	A+	
Presión sonora - Sound level		dB(A)	41	42	42	44	
Potencia sonora - Sound power		dB(A)	51	52	52	54	
Método de regulación - Throttling method		-	EEV	EEV	EEV	EEV	
Dimensiones - Dimensions (LxPxH)		mm	470 x 300 x 480	500 x 300 x 530	500 x 300 x 530	500 x 300 x 670	
Peso - Weight		Kg	33	34	37	42	
Compresor - Compressor		-	Panasonic	Panasonic	Panasonic	Mitsubishi	
Refrigerante Refrigerant	Tipo - Type	-	R32	R32	R32	R32	
	Precarga - Precharge	Kg	0,75	1,10	1,30	1,80	
	Carga adicional - Add. Charge	gr/m	22	22	22	22	
Tuberías frigoríficas Refrigeration pipes	Dimensiones - Dimensions	Inch	1/4" - 3/8"	1/4" - 1/2"	1/4" - 5/8"	3/8" - 5/8"	
	Distancia máxima con precarga Max distance with pre-charge	m	7,5	10	10	10	
	Distancia máxima admisible entre U.I. y U.E. Max allowable distance between IU and OU	m	15	20	30	40	
	Desnivel máximo admisible entre U.I. y U.E. Max elevation difference between IU and OU	m	5	5	5	5	
Conexiones de agua - Water connections		Inch	1/2"	1/2"	1/2"	1/2"	
Presión óptima del agua de entrada - Optimal inlet water pressure		bar	1,5 - 2,0	1,5 - 2,0	1,5 - 2,0	1,5 - 2,0	
Consumo de agua Use of water Potencia - Capacity 15% / 100%	Refrigeración - Cooling	m ³ /h	0,41	0,62	0,86	1,37	
	Calefacción - Heating	m ³ /h	0,39	0,59	0,81	1,41	
Temperatura ajustable Set temperature range	Unidad interior - Indoor Unit	°C	+16~+31	+16~+31	+16~+31	+16~+31	
Límites de funcionamiento* Operating limits*	Agua de entrada MÍN Calef. / MÁX Refrig Inlet Water MIN Heating / MAX cooling	°C	+12 / +25	+12 / +25	+12 / +25	+12 / +25	

N.B.: la normativa no contempla SEER y SCOP para las unidades agua-aire | The regulations do not require SEER and SCOP for water-to-air units.

Condiciones de prueba IDRA Refrigeración: agua entrada/salida 25/30 °C
Calefacción: agua entrada/salida 15/10 °C.

Condiciones de prueba unidad interior Refrigeración: unidad interior 27 °C
 B.S. **Calefacción:** unidad interior 20 °C B.S.

Testing conditions for IDRA Cooling: water inlet/outlet 25/30°C
Heating: water inlet/outlet 15/10°C.

Testing conditions for indoor unit: Cooling: indoor unit at 27°C D.B.
 Heating: indoor unit at 20°C D.B.

* Para agua de entrada con temperatura comprendida entre 7 °C y 12 °C es necesario utilizar el "KIT BT IDRA".

* For incoming water with a temperature between 7°C and 12°C, it is necessary to use the "KIT BT IDRA."



La versión RING de IDRA se beneficia de todas las ventajas de la condensadora de agua invisible y de la elección personalizada de cada unidad interior, combinadas con la conexión al circuito hidráulico de climatización presente en los edificios comerciales más modernos.

The RING version of IDRA benefits from all the advantages of the invisible water-cooled condenser and the customised choice of each indoor unit combined with the connection to the hydronic circuit for air conditioning found in most modern commercial buildings.

IDRA_{ring} MULTISPLIT

UNIDAD CONDENSADORA OCULTA PARA ANILLO DE AGUA
INVISIBLE CONDENSING UNIT FOR WATER LOOP



IDRA2-R18



IDRA3-R24



IDRA4-R28 | IDRA4-R36

IDRA2 R 18.000 BTU - 5,2 kW
IDRA3 R 24.000 BTU - 7,0 kW
IDRA4 R 28.000 BTU - 8,2 kW
IDRA4 R 36.000 BTU - 10,5 kW
combinable - combined with:

Split mural
Wall mounted
SKIV
IMAGINE



Canalizados
Duct unit
DUCT-V
DBIS PLUS



Cassette de 4 vías
Cassette
CASK-CV
CASK-V



Consola
Console
CNS



La circulación en la IDRA RING debe ser garantizada por el gestor del anillo. Datos técnicos y descripciones disponibles en la sección "Unidades interiores ELFO e IDRA".
Circulation in the IDRA RING must be guaranteed by the ring operator. Technical data and descriptions available in the "ELFO and IDRA Indoor Units" section.

Sólo frío - Cooling only

IDRA2-R18C **IDRA4-R28C**
IDRA3-R24C **IDRA4-R36C**

Bomba de calor - Heat Pump

IDRA2-R18H **IDRA4-R28H**
IDRA3-R24H **IDRA4-R36H**

Design Made in Italy

IDRA RING MULTISPLIT

UNIDAD CONDENSADORA OCULTA PARA ANILLO DE AGUA

INVISIBLE CONDENSING UNIT FOR WATER LOOP



IDRA RING Multisplit DC inverter							
Sólo frío - Only Cooling			Cod.	IDRA2-R18C	IDRA3-R24C	IDRA4-R28C	IDRA4-R36C
Bomba de calor - Heat Pump			Cod.	IDRA2-R18H	IDRA3-R24H	IDRA4-R28H	IDRA4-R36H
Alimentación - Power Supply			V-Hz-Ph	230-50-1	230-50-1	230-50-1	230-50-1
Protección contra sobrecorriente - Max Overcurrent Protection			A	25	25	25	25
Sección cables alimentación - Power cable cross-sectional area			mm ²	3 x 2,5	3 x 2,5	3 x 4,0	3 x 4,0
Refrigeración Cooling	Potencia Capacity	Nominal	W/BTU	5200/17742	7000/23884	8200/28000	10500/35826
		Min/Max	W	2100/5900	2300/7800	2300/9100	12100/41285
	Consumo eléctrico Max power absorbtion	Nominal	W	1140	1620	1880	2230
		Min/Max	W	360/1790	650/2100	650/2900	750/4100
EER			W/W	4,57	4,31	4,36	4,71
Clase energética - Energy class			-	A++	A++	A++	A++
Calefacción Heating	Potencia Capacity	Nominal	W/BTU	5200/17742	7000/23884	8200/28000	10500/35826
		Min/Max	W	2100/5900	2300/7800	2300/9100	3100/12100
	Consumo eléctrico Max power absorbtion	Nominal	W	1130	1600	1850	2330
		Min/Max	W	350/1820	650/2100	650/2700	650/3500
COP			W/W	4,59	4,37	4,43	4,5
Clase energética - Energy class			-	A+	A+	A+	A+
Presión sonora - Sound level			dB(A)	42	42	42	44
Potencia sonora - Sound power			dB(A)	52	52	52	54
Método de regulación - Throttling method			-	EEV	EEV	EEV	EEV
Dimensiones - Dimensions (LxPxH)			mm	500 x 300 x 530	500 x 300 x 670	500 x 300 x 750	500 x 300 x 750
Peso - Weight			Kg	35	38	40	42
Compresor - Compressor			-	Panasonic	Panasonic	Panasonic	Mitsubishi
Refrigerante Refrigerant	Tipo - Type		-	R32	R32	R32	R32
	Precarga - Precharge		Kg	1,10	1,30	1,50	1,90
	Carga adicional - Add. Charge		gr/m	22	22	22	22
Tuberías frigoríficas Refrigeration pipes	Dimensiones - Dimensions		Inch	1/4" - 3/8" x2	1/4" - 3/8" x3	1/4" - 3/8" x4	1/4" - 3/8" x2 1/4" - 1/2" x2
	Distancia máxima con precarga Max distance with pre-charge		m	10	10	20	20
	Distancia máxima admisible entre U.I. y U.E. Max allowable distance between IU and OU		m	10 / 20	10 / 30	10 / 40	10 / 40
	Desnivel máximo admisible entre U.I. y U.E. Max elevation difference between IU and OU		m	5	5	5	5
Conexiones de agua - Water connections			Inch	1/2"	1/2"	1/2"	1/2"
Presión óptima del agua de entrada - Optimal inlet water pressure			bar	1,5 - 2,0	1,5 - 2,0	1,5 - 2,0	1,5 - 2,0
Consumo de agua Use of water	Refrigeración - Cooling		m ³ /h	0,61	0,86	0,93	1,24
	Calefacción - Heating		m ³ /h	0,58	0,80	0,88	1,26
Temperatura ajustable Set temperature range			Unidad interior - Indoor Unit	°C	+16~+31	+16~+31	+16~+31
Límites de funcionamiento* Operating limits*			Agua de entrada MÍN Calef. / MÁX Refrig Inlet Water MIN Heating / MAX cooling	°C	+12 / +25	+12 / +25	+12 / +25

N.B.: la normativa no contempla SEER y SCOP para las unidades agua-aire | The regulations do not require SEER and SCOP for water-to-air units.

Condiciones de prueba IDRA Refrigeración: agua entrada/salida 25/30 °C
Calefacción: agua entrada/salida 15/10 °C.

Condiciones de prueba unidad interior Refrigeración: unidad interior 27 °C
 B.S. **Calefacción:** unidad interior 20 °C B.S.

* Para agua de entrada con temperatura comprendida entre 7 °C y 12 °C es necesario utilizar el "KIT BT IDRA".

Testing conditions for IDRA Cooling: water inlet/outlet 25/30°C
Heating: water inlet/outlet 15/10°C.

Testing conditions for indoor unit: Cooling: indoor unit at 27°C D.B.
 Heating: indoor unit at 20°C D.B.

* For incoming water with a temperature between 7°C and 12°C, it is necessary to use the "KIT BT IDRA."

ACERCA DE IDRA ABOUT IDRA

INSTALACIÓN EN ANILLO DE AGUA COMERCIAL INSTALLATION ON COMMERCIAL WATER RING

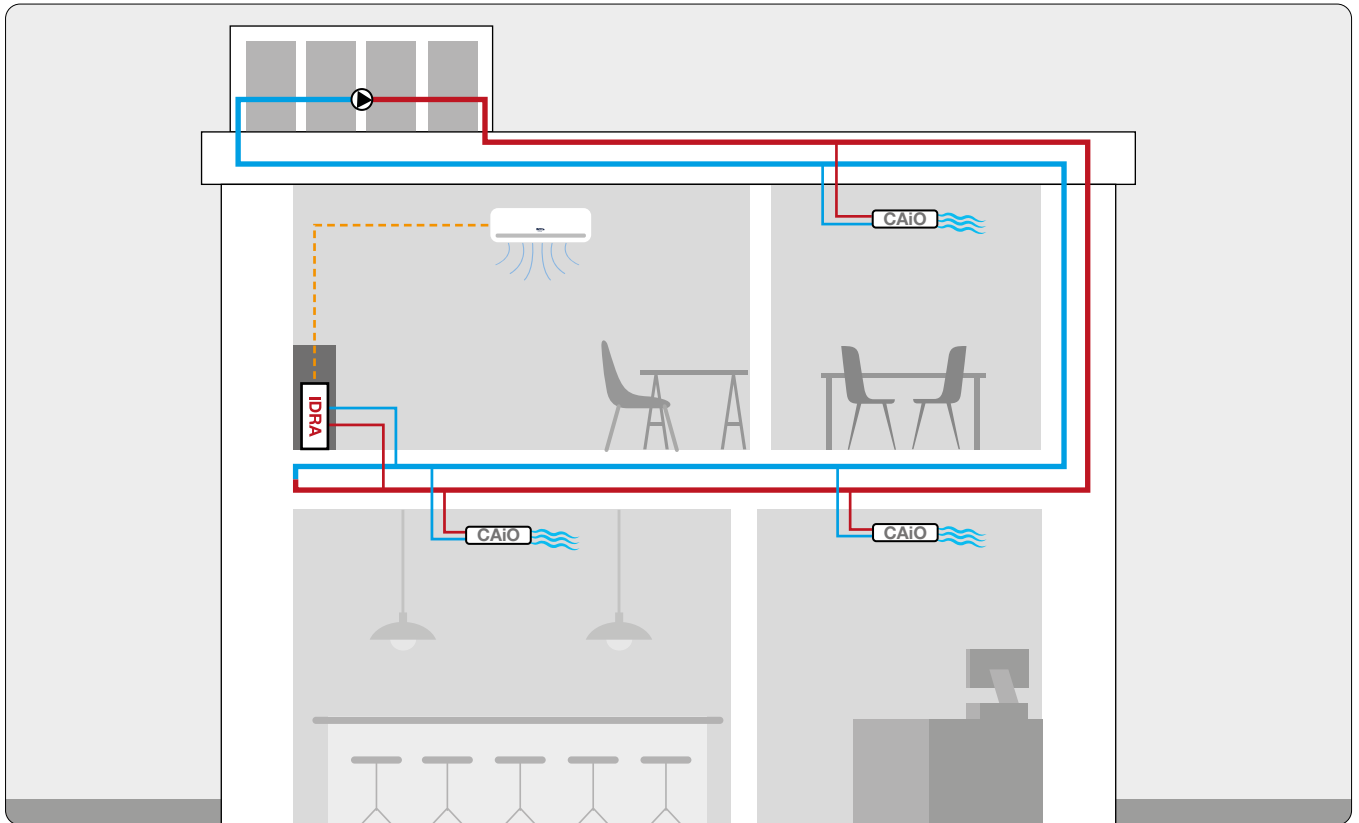

IDRA RING es un sistema de climatización en bomba de calor agua-aire con unidad motocondensadora oculta, diseñada específicamente para funcionar con un circuito hidráulico en anillo. Las instalaciones de climatización en anillo de agua WLHP (Water Loop Heat Pump) se basan en el uso de equipos autónomos que funcionan con bomba de calor y en climatización del tipo agua-aire o también agua-agua. El sistema de climatización en anillo de agua se utiliza en Estados Unidos desde hace más de 30 años y se está difundiendo rápidamente también en Europa. Sus ventajas se pueden resumir en simplicidad, flexibilidad de uso y eficiencia energética. Está basado en el empleo de equipos autónomos interconectados mediante un anillo de agua que actúa como fuente de calor en fase invernal y como sistema de disipación de calor en fase estival. El sistema es particularmente adecuado para aplicaciones como oficinas, hoteles y centros comerciales, en especial cuando se caracterizan por cargas de refrigeración incluso en invierno. En edificios con diferentes exposiciones, el anillo de agua permite realizar de manera eficaz y sencilla la recuperación de calor.

The **IDRA RING** is an air-to-water heat pump climate control system with a concealed condenser unit, specifically designed to operate with a water loop hydronic circuit. WLHP (Water Loop Heat Pump) water-loop conditioning systems are based on autonomous equipment that operates in heat pump mode and provides either air-to-water or water-to-water conditioning. The water-loop climate control system has been widely used in the United States for over 30 years and is rapidly spreading across Europe. Its advantages include simplicity, flexibility, and energy efficiency. This system relies on autonomous units connected through a water loop, which serves as a heat source in winter and a heat disposal system in summer. The setup is especially suitable for buildings like offices, hotels, and shopping centers, particularly those with cooling requirements even during winter. In buildings with diverse exposures, the water loop effectively and easily facilitates heat recovery.

INSTALACIÓN EN ANILLO DE AGUA RESIDENCIAL

INSTALLATION ON RESIDENTIAL WATER RING

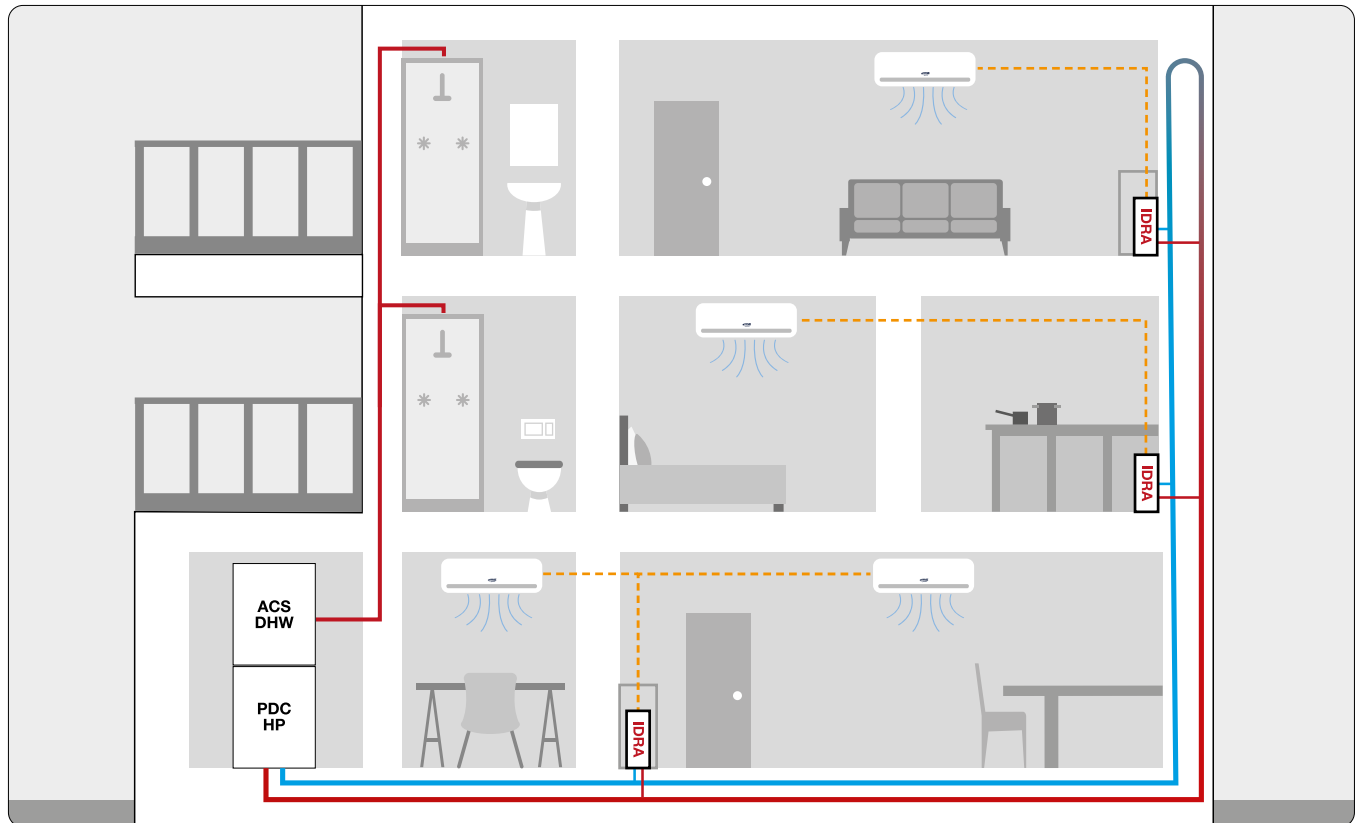

No debe subestimarse la posibilidad de utilizar **IDRA RING** también en contextos residenciales. Durante la rehabilitación de un inmueble, a menudo se descarta la posibilidad de sustituir la caldera por una bomba de calor debido a todas las intervenciones necesarias en las tuberías existentes, que con frecuencia no están suficientemente aisladas y presentan diámetros insuficientes para permitir la circulación de agua fría para la climatización estival. Estas intervenciones son invasivas y, en muchos casos, se evitan a causa de los elevados costes. Con **IDRA RING**, es posible rehabilitar un edificio y utilizar el nuevo sistema tanto en verano como en invierno sin necesidad de intervenir en las tuberías existentes. El agua en la instalación circulará durante todo el año a una temperatura neutra, entre 20 °C y 30 °C, y **IDRA RING** aprovechará esa energía para calentar o enfriar cada vivienda. Esta solución implica además una reducción de los consumos y un aumento de la eficiencia en comparación, por ejemplo, con un sistema de fancoil, donde el agua debe estar a 45 °C para el funcionamiento en invierno y a 8-10 °C en verano. Es suficiente instalar incluso una sola **IDRA RING** por cada unidad de vivienda, combinándola con varias unidades interiores, lo que permite gestionar de forma autónoma y óptima la climatización de las diferentes estancias.

However, the possibility of using **IDRA RING** in **residential contexts** should not be underestimated. During the renovation of a building, the option of replacing the boiler with a heat pump is often ruled out due to the necessary interventions on the existing piping, which is often poorly insulated and has insufficient diameters. These interventions are needed to allow the circulation of cold water for summer air conditioning, but they are invasive and often avoided due to high costs. With **IDRA RING**, it is possible to upgrade a building and use the new system both in summer and winter without having to intervene on the existing pipes. The water in the system will circulate year-round at a neutral temperature, between 20°C and 30°C, and **IDRA RING** will use this energy to heat or cool each apartment. This solution also reduces consumption and increases efficiency compared to, for example, a fan coil system where the water must be at 45°C for winter operation and 8-10°C in summer. It is sufficient to install even a single **IDRA RING** for each housing unit, pairing it with multiple internal units, thus allowing independent and optimal management of the climate control in the various rooms.

ACERCA DE IDRA ABOUT IDRA

INSTALACIÓN EN ANILLO DE AGUA RESIDENCIAL CON RECUPERACIÓN DE AGUAS PLUVIALES

INSTALLATION ON RESIDENTIAL WATER RING WITH RAINWATER RECOVERY

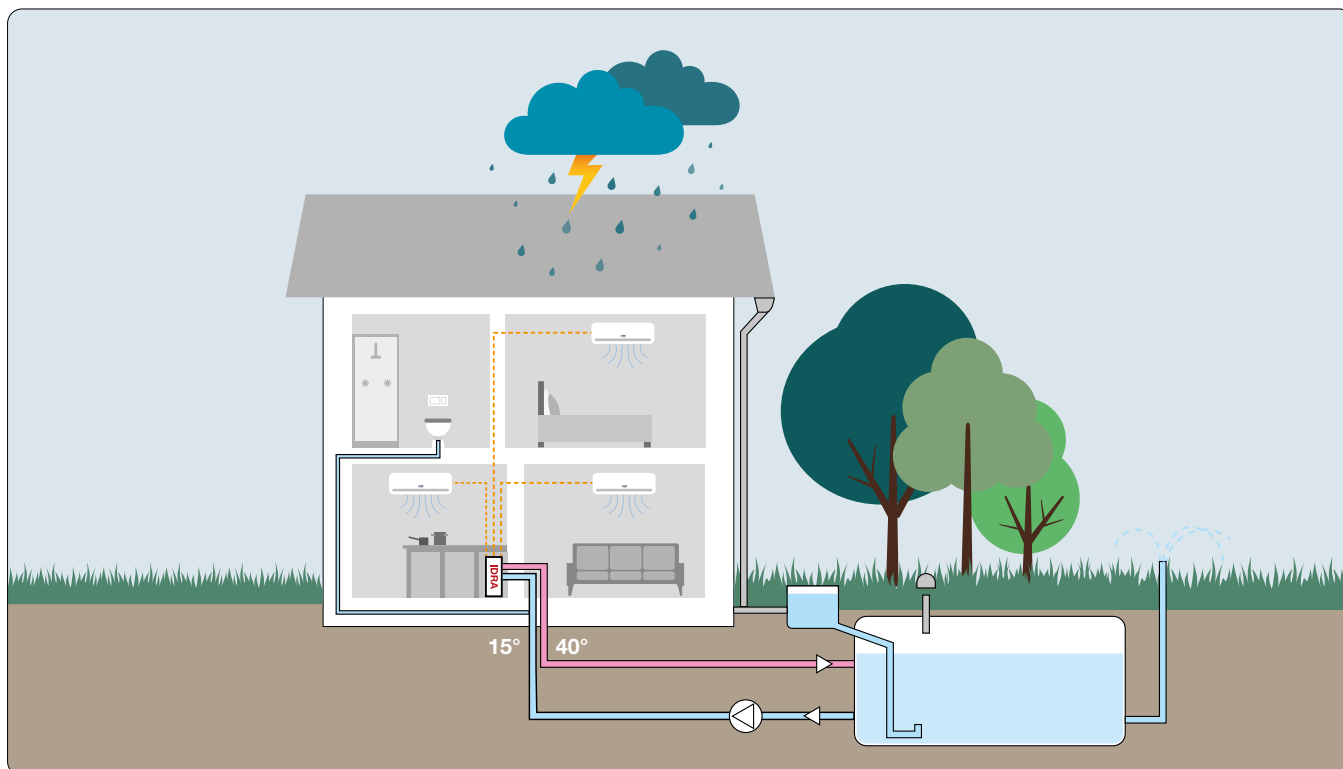

La nueva edificación residencial presta cada vez más atención al uso de **fuentes renovables**, entre ellas el **agua de lluvia**. Si se recoge y se canaliza adecuadamente hacia una cisterna de almacenamiento, **puede reutilizarse como reserva térmica para la climatización del edificio**.

Con Idra, unidad condensada por agua, **es posible valorizar este recurso creando un circuito cerrado**, debidamente filtrado, en el que el agua se pone en circulación y se envía a la unidad. De este modo, se aprovecha la energía térmica contenida en el depósito, constantemente reintegrada tanto mediante el intercambio con el terreno como gracias a la renovación natural del agua con cada nueva precipitación.

Este sistema permite climatizar el edificio utilizando una fuente con temperatura prácticamente estable durante todo el año, reduciendo las pérdidas de eficiencia típicas de los periodos climáticos más extremos.

Modern residential construction is increasingly focused on the use of **renewable resources**, including rainwater. When properly collected and stored in a dedicated tank, **it can be reused as a thermal reserve for building climate control**.

With IDRA, a water-cooled unit, **this resource can be effectively utilized by creating a closed**, properly filtered loop in which the water is circulated and conveyed to the unit. This allows the thermal energy stored in the tank to be exploited, continuously replenished both through heat exchange with the ground and through the natural renewal of the water volume with each new rainfall.

This solution enables the building to be climatized using a source with a nearly constant temperature throughout the year, minimizing the efficiency losses typically associated with the most extreme seasonal conditions.

CASO DE ESTUDIO: RECUPERACIÓN DE AGUA DE LLUVIA EDIFICIOS DE NUEVA CONSTRUCCIÓN - LUXEMBURGO

CASE STUDY: RAINWATER RECOVERY - NEW CONSTRUCTION BUILDINGS - LUXEMBOURG



Complejo residencial de nueva construcción diseñado con un enfoque integrado que pone en el centro la eficiencia energética, la autonomía hídrica y la coherencia arquitectónica.

Cada decisión está orientada a reducir el consumo y a valorizar las características climáticas del territorio. La elevada pluviometría de la región se convierte así en un recurso estratégico para lograr la máxima eficiencia energética.

La instalación se estructura en un anillo de agua compuesto por:

- bomba de calor agua-aire IDRA
- depósito de almacenamiento de 60.000 l
- sistema de recuperación de agua de lluvia
- bomba de recirculación en circuito cerrado

El agua de lluvia se recoge y se almacena en cisternas enterradas, luego se filtra y se introduce en un circuito cerrado que alimenta las unidades IDRA y las cisternas de descarga de los WC. Este sistema permite mejorar la eficiencia global, reducir el consumo y aumentar la autonomía del edificio respecto a las redes públicas, tanto eléctrica como hídrica.

Newly built residential complex designed with an integrated approach that places energy efficiency, water self-sufficiency, and architectural coherence at its core.

Every choice is aimed at reducing consumption and enhancing the specific climatic characteristics of the region. The area's high rainfall is therefore transformed into a strategic resource to achieve maximum energy containment.

The system is structured around a water loop consisting of:

- IDRA air-to-water heat pump
- thermodynamic storage tank
- rainwater recovery system
- closed-loop booster pump

Rainwater is collected and stored in underground tanks, then filtered and fed into a closed-loop system that supplies the IDRA units and the toilet flushing systems. This solution improves overall efficiency, reduces consumption, and increases the building's independence from public utility networks, both electrical and water.

RECOMENDACIONES DE INSTALACIÓN PARA IDRA INSTALLATION TIPS FOR IDRA

A continuación se indican algunos consejos útiles que deben seguirse durante la fase de instalación de Idra:



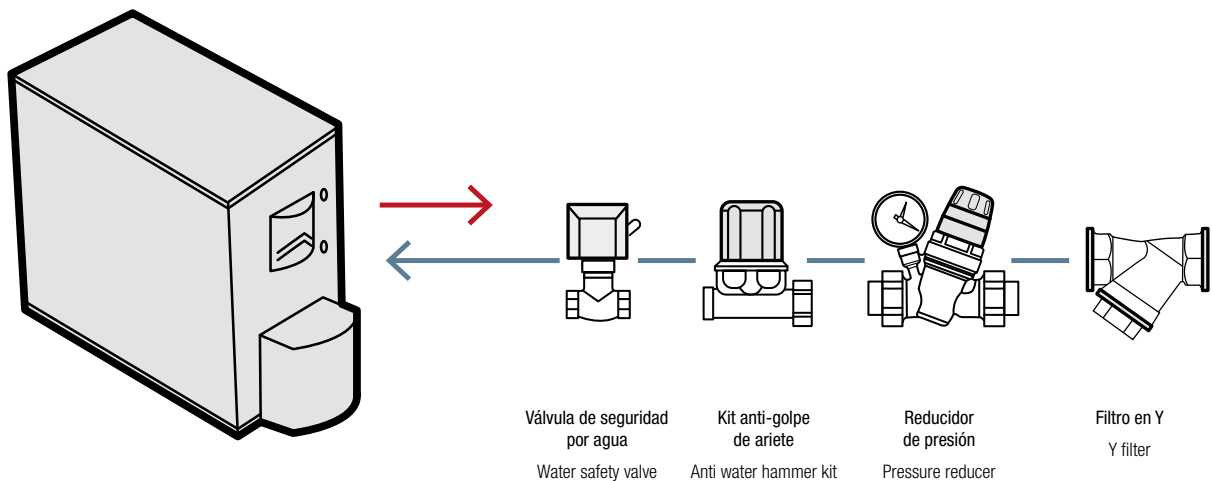

Below are some **useful tips to follow during the installation phase of the Idra:**

- **La alimentación de agua debe estar garantizada** tanto para el funcionamiento al mínimo como para el funcionamiento a la máxima capacidad. Es fundamental conectar una tubería correctamente dimensionada de acuerdo con las especificaciones indicadas en el manual de instalación.
 - **Prever y mantener limpios los sistemas de filtrado en la entrada de la unidad**, eligiéndolos adecuadamente en función de la fuente de suministro (filtro en Y, filtro desfangador magnético, ...) o bien optar por crear un circuito secundario con separador hidráulico (en los casos de anillo, pozo, agua salada, agua clorada, ...).
 - **Prever el magnetotérmico adecuado** en función de la presencia o no del Kit BT alimentado directamente desde la unidad.
 - **Respetar las longitudes máximas de las líneas frigoríficas** según el manual y cargar la cantidad correcta de gas adicional si fuese necesario.
 - **Respetar las distancias mínimas de instalación** según el manual, con el fin de garantizar el futuro mantenimiento y conservar la garantía.
- **Water supply:** ensure water supply is guaranteed for both minimum and maximum capacity operation. It is essential to connect properly sized piping in accordance with the specifications provided in the installation manual.
 - **Filtration systems:** Plan for and maintain clean filtration systems at the unit's inlet, selecting them appropriately based on the water source (Y filter, magnetic dirt separator, etc.), or consider creating a secondary circuit with a hydraulic separator (in cases of water from a ring, well, salty water, chlorinated water, etc.).
 - **Magnetothermal switch:** choose the appropriate magnetothermal switch depending on whether the BT Kit is powered directly by the unit.
 - **Refrigeration lines:** Respect the maximum lengths of refrigerant lines as specified in the manual and charge the correct amount of additional gas if necessary.
 - **Installation clearances:** Adhere to the minimum installation distances specified in the manual to ensure future maintenance access and preserve the warranty.

SECUENCIA DE INSTALACIÓN RECOMENDADA DE LOS ACCESORIOS IDRA RECOMMENDED INSTALLATION SEQUENCE OF IDRA ACCESSORIES

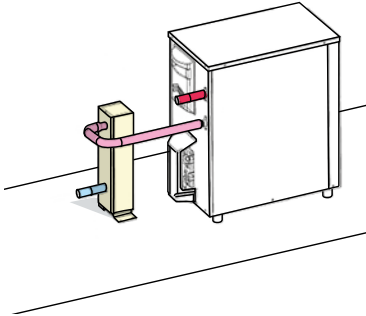

ACCESORIOS PARA IDRA ACCESSORIES FOR IDRA

	Código Code	Descripción Description	Modelo Model
	KIT BT IDRA	<p>Con el Kit de Baja Temperatura para IDRA Next es posible aumentar en algunos grados la temperatura del agua de entrada proveniente de la red hidráulica gracias a su resistencia eléctrica de 2 kW, satisfaciendo así los límites de funcionamiento de la máquina.</p> <p>With the Low Temperature Kit for IDRA Next, it is possible to increase the temperature of the incoming water from the water supply by a few degrees thanks to its 2kW electric heating element, thus meeting the machine's operating limits.</p>	IDRA Next (sólo bomba de calor - only for heat pump)
	KIT SST IDRA	<p>Kit super silent para la reducción de la potencia sonora percibida. Adecuado para instalaciones sensibles.</p> <p>Kit super silent for lowering the perceived sound power. Suitable for sensitive installations.</p>	IDRA (todos los modelos - all models)
	KIT AWHAM	<p>Kit anti-golpe de ariete. Reduce las variaciones de presión del circuito de alimentación de agua que podrían causar ruidos y vibraciones indeseadas.</p> <p>Anti water hammer kit. Reduces pressure surges in the water supply circuit that could cause unwanted noise and vibration.</p>	IDRA (todos los modelos - all models)
	RID-PR1	<p>Reductor de presión 1/2" M-H con manómetro y termómetro integrados.</p> <p>Pressure reducing valve 1/2" M-F with integrated pressure gauge and thermometer.</p>	IDRA-12
	RID-PR2	<p>Reductor de presión 3/4" M-H con manómetro y termómetro integrados.</p> <p>Pressure reducing valve 3/4" M-F with integrated pressure gauge and thermometer.</p>	IDRA-18 IDRA-24
	RID-PR3	<p>Reductor de presión 1" M-H con manómetro y termómetro integrados.</p> <p>Pressure reducing valve 1" M-F with integrated pressure gauge and thermometer.</p>	IDRA-28 IDRA-36
	VALSIC	<p>Válvula de seguridad de agua normalmente cerrada. La válvula se cierra en caso de falta de corriente, apagado de la unidad o error de la unidad.</p> <p>Normally closed safety water valve. The valve closes in case of power failure, unit shutdown and unit in error.</p>	IDRA (todos los modelos - all models)



Módulo R3, proyecto firmado por Tekno Point que traduce los principios de **Reduce, Reuse, Recycle** en una acción concreta y medible, nace del concepto de circularidad del agua. En una **perspectiva de sostenibilidad real**, hemos desarrollado un sistema capaz de recuperar el agua utilizada por el **climatizador invisible IDRA**: una cantidad que se acumula, se reutiliza varias veces para la propia IDRA y, finalmente, se reaprovecha de forma inteligente y funcional en la vida cotidiana. Una reserva de agua caliente gratuita disponible para los servicios domésticos. **Un único ciclo, múltiples funciones, mayor eficiencia.**

R3 Module, a project by Tekno Point that turns the principles of **Reduce, Reuse, Recycle** into a concrete and measurable action, is built on the concept of water circularity. **With a truly sustainable approach**, we have developed a system capable of recovering the water produced by **the invisible IDRA air conditioner**: a resource that is collected, reused multiple times by the same IDRA unit, and finally repurposed intelligently and functionally in everyday life. A reserve of free hot water available for domestic services. **One single cycle, multiple functions, greater efficiency.**



SISTEMA INTELIGENTE DE RECUPERACIÓN DEL AGUA INTELLIGENT WATER RECOVERY SYSTEM

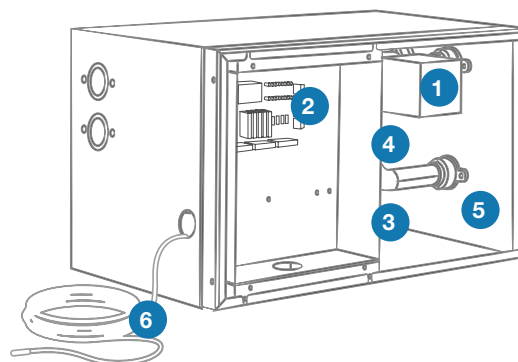

COMPONENTES

- 1- Válvula de 3 vías
- 2- Tarjeta electrónica
- 3- Válvula de retención
- 4- Bomba de circulación
- 5- Estructura insonorizada
- 6- Sonda de temp. para acumulación técnica

COMPONENTS

- 1- 3-way valve
- 2- Electronic board
- 3- Return valve
- 4- Circulation pump
- 5- Soundproof structure
- 6- Temperature probe for technical storage tank

R3

SISTEMA INTELIGENTE DE RECUPERACIÓN DEL AGUA

INTELLIGENT WATER RECOVERY SYSTEM

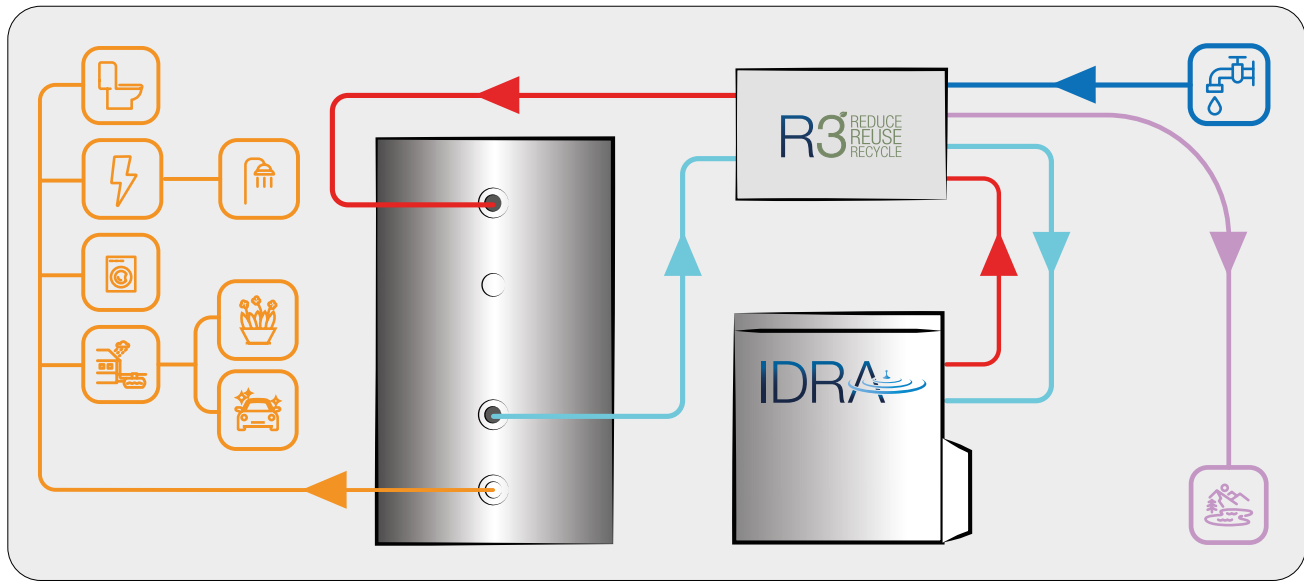

Cuando Idra se instala con alimentación de agua a pérdida, **el módulo R3 permite reducir los consumos**. Combinado con un acumulador de agua sanitaria, **R3 gestiona automáticamente el paso entre circuito cerrado y reposición desde la red**, permitiendo reutilizar para usos domésticos el agua empleada en la climatización.

Si la temperatura en el acumulador es inferior a 30°C, no habrá aporte desde la red, el circuito permanece cerrado y el agua se recircula. Cada vez que se vacía el acumulador gracias a los usos cotidianos, el proceso se ralentiza y se alargan los tiempos de climatización sin uso de agua adicional.

Si, por el contrario, supera el umbral de 30°C, R3 introduce agua fresca desde la red para restablecer los valores correctos. Cuanto mayor sea la capacidad del acumulador y el consumo doméstico, más tiempo podrá Idra funcionar sin tomas directas, **garantizando confort con el mínimo uso de agua**.

When Idra is installed with a once-through water supply, **the R3 module helps reduce consumption**. When combined with a domestic hot water storage tank, **R3 automatically manages the switch between closed-loop operation and mains water replenishment**, allowing the water used for air conditioning to be reused for domestic purposes.

If the temperature in the storage tank is below 30°C, no water is drawn from the mains: the circuit remains closed and the water is recirculated. Each time the tank is emptied through normal daily use, the process slows down, extending the air-conditioning operation without dedicated water consumption.

If it exceeds the 30°C threshold, R3 introduces fresh water from the mains supply to restore it to the correct values. The greater the storage capacity and domestic consumption, the longer Idra can operate without direct mains intake, **ensuring comfort with minimal water use**.

Modulo R3		
Código - Code	-	R3
Alimentación - Power Supply	V-Hz-Ph	230-50-1
Protección contra sobrecorriente - Max Overcurrent Protection	A	6
Sección de los cables de alimentación - Power cable cross-sectional area	mm²	3x1,5
Presión sonora - Sound level (Lp)	dB(A)	18
Potencia sonora - Sound power (Lw)	dB(A)	30
Dimensiones - Dimensions (LxPxH)	mm	500x312,5x275
Peso - Weight	Kg	16
Circulador - Circulation pump	-	SHIMGE APM25-12-180
Conexiones de agua - Water connections	Inch	1"
Presión óptima del agua de entrada - Optimal inlet water pressure	bar	2,5

UNIDADES INTERIORES INDOOR UNITS

ELFO E IDRA SPLIT MURAL Wall mounted IMAGINE

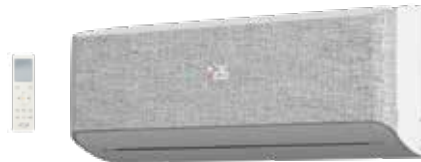

La unidad interior **Imagine** representa el equilibrio perfecto entre tecnología avanzada y diseño personalizable, concebida para integrarse armoniosamente en cualquier ambiente. Disponible en acabados blanco o negro, ofrece la posibilidad de personalizar su aspecto gracias a paneles intercambiables con acabado en tejido, disponibles en tres elegantes colores:

- **Negro** para un estilo moderno y sofisticado;
- **Beige** para un ambiente cálido y acogedor;
- **Gris** para un look elegante y atemporal.

Con paneles fácilmente sustituibles, la unidad Imagine no solo garantiza altas prestaciones de refrigeración y calefacción, sino que también se transforma en un verdadero elemento decorativo, capaz de enriquecer la decoración de tu espacio.

Función de autolimpieza

Pulsando el botón "Self cleaning", el climatizador inicia un ciclo de congelación, desescarche y secado para eliminar la humedad, prevenir bacterias y mantener el aire fresco, garantizando un rendimiento óptimo.

Mantenimiento fácil sin uso de herramientas

Diseñada para un mantenimiento sencillo, el filtro, el panel de guía del aire y la aleta son fáciles de desmontar. El filtro, extraíble desde la parte superior, garantiza un mantenimiento rápido, facilitando el acceso a la ventilación y la limpieza de toda la unidad.

The **Imagine** indoor unit embodies the perfect balance between advanced technology and customizable design, crafted to seamlessly integrate into any environment. Available in white or black finishes, it offers the option to personalize its appearance with interchangeable fabric-finish panels in three elegant colors:

- **Black** for a modern and sophisticated style;
- **Beige** for a warm and inviting atmosphere;
- **Gray** for a timeless and elegant look.

With easily replaceable panels, the Imagine unit not only delivers exceptional cooling and heating performance but also becomes a true decorative element, enhancing the aesthetics of your space.

Self-Cleaning Function

By pressing the "Self Cleaning" button, the air conditioner initiates a cycle of freezing, defrosting, and drying to eliminate moisture, prevent bacteria, and keep the air fresh, ensuring optimal performance.

Easy Maintenance Without Tools

Designed for easy maintenance, the filter, air guide panel, and fin are easy to remove. The top-removable filter ensures quick maintenance, facilitating access to ventilation and cleaning of the entire unit.

Split mural - Wall-mounted indoor unit					IMG-07-WH	IMG-07-BL	IMG-09-WH	IMG-09-BL	IMG-12-WH	IMG-12-BL
Código - Code			-							
Alimentación - Power Supply			V-Hz-Ph	230-50-1	230-50-1	230-50-1	230-50-1	230-50-1	230-50-1	230-50-1
Refrigeración Cooling	Potencia Capacity	Nominal	W/BTU	2100/7200	2100/7200	2600/8900	2600/8900	3600/11900	3600/11900	3600/11900
Calefacción Heating	Potencia Capacity	Nominal	W/BTU	2300/7800	2300/7800	2800/9600	2800/9600	3650/12500	3650/12500	3650/12500
Caudal de aire - Air flow			m³/h	500	500	600	600	700	700	700
Presión sonora - Sound level (SHi, Hi, Med, Lo, Quiet)			dB(A)	41/37/29/27/18	41/37/29/27/18	41/37/29/27/18	41/37/29/27/18	41/37/29/27/18	41/37/29/27/18	41/37/29/27/18
Potencia sonora - Sound power SHi, Hi, Med, Lo, Quiet)			dB(A)	53/49/41/39/30	53/49/41/39/30	53/49/41/39/30	53/49/41/39/30	53/49/41/39/30	53/49/41/39/30	53/49/41/39/30
Dimensiones - Dimensions (LxPxH)			mm	820x210x302	820x210x302	820x210x302	820x210x302	820x210x302	820x210x302	820x210x302
Peso - Weight			Kg	9	9	9	9	10	10	10
Tuberías frigoríficas Refrigeration piping	Dimensiones Dimensions		inch	1/4"-3/8"	1/4"-3/8"	1/4"-3/8"	1/4"-3/8"	1/4"-3/8"	1/4"-3/8"	1/4"-3/8"
Temperatura ajustable Set temperature range	Ambiente interior (refrig/calef) Indoor (heat/cool)		°C	+16~+31	+16~+31	+16~+31	+16~+31	+16~+31	+16~+31	+16~+31

UNIDADES INTERIORES INDOOR UNITS

IMAGINE Y SUS COMPONENTES IMAGINE AND ITS COMPONENTS

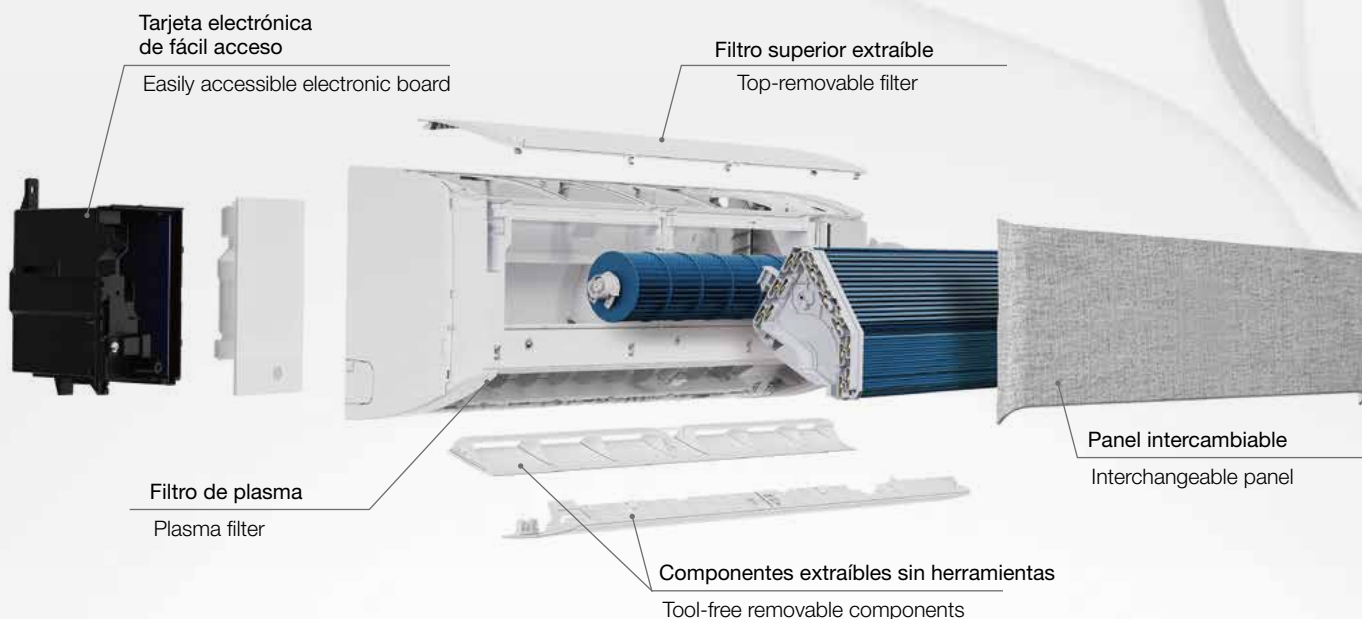

ELIGE EL ACABADO DEL PANEL EN EL TEJIDO QUE PREFIERAS CHOOSE THE PANEL FINISH IN THE FABRIC YOU PREFER

ESTÁNDAR | STANDARD

OPCIONAL | OPTIONAL



Carcasa blanca | White Shell



Carcasa negra | Black Shell



Tejido negro | Black fabric



Tejido beige | Beige fabric



Tejido gris | Grey fabric

UNIDADES INTERIORES INDOOR UNITS

ELFO E IDRA

SPLIT MURAL

Wall mounted

SKIV



Unidad interior mural Skiv, de diseño agradable y armonioso, equipada con motor brushless, regulación progresiva de la ventilación y filtro de plasma. Preparada para Wi-Fi.

Skiv indoor unit wall, pleasant and harmonious design, equipped with a brushless motor, progressive adjustment of ventilation and a plasma filter. Wi-fi ready.

Unidad interior de pared - Wall-mounted indoor unit

Código - Code		-	SKIV-07	SKIV-09	SKIV-12	SKIV-18	SKIV-24
Alimentación - Power Supply		V-Hz-Ph	230-50-1	230-50-1	230-50-1	230-50-1	230-50-1
Refrigeración Cooling	Potencia Capacity	W/BTU	2100/7200	2600/8900	3500/11900	5270/18000	6450/22000
Calefacción Heating	Potencia Capacity	W/BTU	2300/7800	2800/9600	3650/12500	5500/18800	6600/22500
Caudal de aire - Air flow		m³/h	520/440/230/150	520/440/230/150	580/500/300/230	850/760/570/480	1090/930/670/560
Presión sonora - Sound level (SHi, Hi, Med, Lo, Quiet)		dB(A)	38/34/21/19	38/34/21/19	40/35/22/20	47/44/31/29	48/44/35/33
Potencia sonora - Sound power (SHi, Hi, Med, Lo, Quiet)		dB(A)	51/47/34/32	51/47/34/32	53/48/35/33	58/55/42/40	61/57/48/46
Dimensiones - Dimensions (LxPxH)		mm	821x200x283	821x200x283	884x205x298	1003x222x310	1109x250x331
Peso - Weight		Kg	9	9	10	13	16
Tuberías frigoríficas Refrigeration piping	Dimensiones - Dimensions	inch	1/4"-3/8"	1/4"-3/8"	1/4"-3/8"	1/4"-1/2"	1/4"-5/8"
Temperatura ajustable Set temperature range	Ambiente interior (refr/cal) Indoor (heat/cool)	°C	+16~+31	+16~+31	+16~+31	+16~+31	+16~+31

CONDUCTO INVERTER HORIZONTAL

Inverter horizontal duct

DUCT-V



Unidad interior canalizada de instalación horizontal y dimensiones reducidas, con contacto seco y motor inverter que permite regular el caudal de aire de forma progresiva. Es posible seleccionar diferentes configuraciones de presión estática, partiendo de 25 Pa estándar.

Horizontal-installation ducted indoor unit with small size with clean contact and inverter motor to adjust airflow rate progressively. different static pressure settings can be selected starting from 25 Pa standard.

Unidad interior canalizada horizontal - Horizontal ducted indoor unit

Código - Code		-	DUCT-09-V	DUCT-12-V	DUCT-18-V	DUCT-24-V	DUCT-36-V	
Alimentación - Power Supply		V-Hz-Ph	230-50-1	230-50-1	230-50-1	230-50-1	230-50-1	
Refrigeración Cooling	Potencia Capacity	Nominal	W/BTU	2500/8530	3500/11942	5000/17060	7000/23884	10000/36000
Calefacción Heating	Potencia Capacity	Nominal	W/BTU	2600/8871	3600/12283	5200/17742	7200/24566	11000/37500
Caudal de aire - Air flow		m³/h	560	560	850	1150	2000	
Presión sonora - Sound level (Turbo, Max, Med, Min)		dB(A)	40/38/36/34	40/38/36/34	43/40/38/36	45/42/40/38	48/46/43/41	
Potencia sonora - Sound power (Turbo, Max, Med, Min)		dB(A)	40/48/46/44	50/48/46/44	53/50/48/46	55/52/50/48	58/56/53/51	
Presión estática - Static pressure		Pa	0-25-50	0-25-50	0-25-50-70	0-25-50-70	0-25-50-70-100	
Dimensiones - Dimensions (LxPxH)		mm	700x450x200	700x450x200	1000x450x200	1300x450x200	1300x680x270	
Peso - Weight		Kg	17	17	22	28	40	
Tuberías frigoríficas Refrigeration piping	Dimensiones - Dimensions	inch	1/4"-3/8"	1/4"-3/8"	1/4"-1/2"	3/8"-5/8"	3/8"-3/4"	
Temperatura ajustable Set temperature range	Ambiente interior (refrig/calef) Indoor (heat/cool)	°C	+16~+31	+16~+31	+16~+31	+16~+31	+16~+31	

CONDICIONES DE PRUEBA: Refrigeración: Int. 27 °C B.S. - Ext. 35 °C B.S. / 24 °C B.U. - Calefacción: Int. 20 °C B.S. - Ext. 7 °C B.S. / 6 °C B.U.

TEST CONDITIONS: Cooling: Int. 27°C D.B. - East 35°C B.S. / 24°C W.B. Heating: Int. 20°C D.B. - East 7°C B.S. / 6°C W.B.

UNIDADES INTERIORES INDOOR UNITS

ELFO E IDRA

CONDUCTO INVERTER HORIZONTAL/VERTICAL

Inverter horizontal/vertical duct

DBIS PLUS

Unidad interior canalizable vertical y horizontal de dimensiones reducidas; la altura reducida permite también instalaciones en espacios muy estrechos. Motor brushless. Bomba de condensados incluida.



LOS INVISIBLES
THE INVISIBLES

Vertical and horizontal duct indoor unit with small dimensions; the reduced height also allows installations in very small spaces. Brushless motor. Condensate pump included.

Unidad interior canalizada horizontal/vertical - Horizontal/vertical ducted indoor unit						
Código - Code				-	DBIS-12 PLUS	DBIS-18 PLUS
Alimentación - Power Supply				V-Hz-Ph	230-50-1	230-50-1
Refrigeración Cooling	Potencia Capacity	Nominal		W/BTU	3300/11300	5000/17100
Calefacción Heating	Potencia Capacity	Nominal		W/BTU	3800/13000	5800/19800
Caudal de aire - Air flow				m³/h	700	850
Presión sonora - Sound level (Turbo, Max, Med, Min)				dB(A)	44	47
Potencia sonora - Sound power (Turbo, Max, Med, Min)				dB(A)	55	58
Presión estática - Static pressure				Pa	30	30
Dimensiones - Dimensions (LxPxH)				mm	730x600x200	730x600x200
Peso - Weight				Kg	17	23
Tuberías frigoríficas Refrigeration piping	Dimensiones - Dimensions			inch	1/4"-3/8"	1/4"-1/2"
Temperatura ajustable Set temperature range	Ambiente interior (refrig/calef) Indoor (heat/cool)			°C	+16~+31	+16~+31
Bomba de desagüe de condensados - Drain pump				-	Sí (solo instalación horizontal) yes (horizontal installation only)	

CONSOLA

Console

CNS

Unidad interior consola de diseño atractivo que se integra perfectamente en oficinas y tiendas.



Console type indoor unit, with attractive design that fits perfectly in commercial environments.

Unidad consola con bomba de calor DC Inverter - Console heat pump DC inverter units						
Código - Code				-	CNS-09	CNS-12
Alimentación - Power Supply				V-Hz-Ph	230-50-1	230-50-1
Refrigeración Cooling	Potencia Capacity	Nominal		W/BTU	2650/9042	3500/11942
Calefacción Heating	Potencia Capacity	Nominal		W/BTU	3200/10918	4000/13648
Caudal de aire - Air flow				m³/h	650	650
Presión sonora - Sound level				dB(A)	39	39
Potencia sonora - Sound power				dB(A)	50	50
Dimensiones - Dimensions (LxPxH)				mm	700x215x600	700x215x600
Peso - Weight				Kg	16	16
Tuberías frigoríficas Refrigeration piping	Dimensiones - Dimensions			inch	1/4"-3/8"	1/4"-3/8"
Temperatura ajustable Set temperature range	Ambiente interior (refrig/calef) Indoor (heat/cool)			°C	+16~+31	+16~+31

CONDICIONES DE PRUEBA: Refrigeración: Int. 27 °C B.S. - Ext. 35 °C B.S. / 24 °C B.U. Calefacción: Int. 20 °C B.S. - Ext. 7 °C B.S. / 6 °C B.U.

TEST CONDITIONS: Cooling: Int. 27°C D.B. - East 35°C B.S. / 24°C W.B. Heating: Int. 20°C D.B. - Ext 7°C B.S. / 6°C W.B.

UNIDADES INTERIORES INDOOR UNITS

ELFO E IDRA

CASSETAS COMPACTAS

Cassette compact

CASK-CV



Unidad interior tipo cassette de techo, completa con bomba de drenaje de condensados, que se integra perfectamente en oficinas y tiendas.

Cassette type indoor unit, complete with condensate drain pump, perfectly suited for offices and stores.

Unidades interiores tipo cassette (570x570mm) - Indoor cassette unit (570x570mm)

Código - Code				-	CASK-12CV	CASK-18CV
Alimentación - Power Supply				V-Hz-Ph	230-50-1	230-50-1
Refrigeración Cooling	Potencia Capacity	Nominal	W/BTU	3500/11942	5200/17742	
Calefacción Heating	Potencia Capacity	Nominal	W/BTU	3500/11942	5200/17742	
Caudal de aire - Air flow				m³/h	700	760
Presión sonora - Sound level				dB(A)	47	47
Potencia sonora - Sound power				dB(A)	58	58
Cassette - Cassette	Dimensiones - Dimensions (LxPxH)			mm	570x570x260	570x570x260
	Peso - Weight			Kg	19	19
Panel - Panel	Dimensiones - Dimensions (LxPxH)			mm	650x650x28	650x650x28
	Peso - Weight			Kg	2,2	2,2
Tuberías frigoríficas Refrigeration piping		Dimensiones - Dimensions		inch	1/4"-1/2"	1/4"-1/2"
Temperatura ajustable Set temperature range		Ambiente interior (refrig/calef) Indoor (heat/cool)		°C	+16~+31	+16~+31
Bomba de condensados - Drain pump				-		si - yes

CASSETAS

Cassette

CASK-V



Unidad interior tipo cassette, completa con bomba de drenaje de condensados y display, perfectamente adaptada para oficinas y tiendas.

Cassette type indoor unit, complete with condensate drain pump and display, perfectly suited for offices and stores.

Unità interne cassette (840x840mm) - Indoor cassette unit (840x840mm)

Código - Code				-	CASK-24-V	CASK-36-V
Alimentación - Power Supply				V-Hz-Ph	230-50-1	230-50-1
Refrigeración Cooling	Potencia Capacity	Nominal	W/BTU	7000/23900	10800/36850	
Calefacción Heating	Potencia Capacity	Nominal	W/BTU	8000/27300	13000/44360	
Caudal de aire - Air flow				m³/h	1100	1700
Presión sonora - Sound level				dB(A)	45	50
Potencia sonora - Sound power				dB(A)	55	61
Cassette - Cassette	Dimensiones - Dimensions (LxPxH)			mm	830x830x230	830x830x290
	Peso - Weight			Kg	25	33
Panel - Panel	Dimensiones - Dimensions (LxPxH)			mm	950x950x65	950x950x65
	Peso - Weight			Kg	8	8
Tuberías frigoríficas Refrigeration piping		Dimensiones - Dimensions		inch	3/8"-5/8"	3/8"-3/4"
Temperatura ajustable Set temperature range		Ambiente interior (refrig/calef) Indoor (heat/cool)		°C	+16~+31	+16~+31
Bomba de condensados - Drain pump				-		si - yes

CONDICIONES DE PRUEBA: Refrigeración: Int. 27 °C B.S. - Ext. 35 °C B.S. / 24 °C B.H. Calefacción: Int. 20 °C B.S. - Ext. 7 °C B.S. / 6 °C B.H.

TEST CONDITIONS: Cooling: Int. 27°C D.B. - Ext 35°C B.S. / 24°C W.B. Heating: Int. 20°C D.B. - Ext 7°C B.S. / 6°C W.B.

COMBINACIONES SOPORTADAS SUPPORTED COMBINATIONS



ELFO Potencia frigorífica de las unidades interiores: BTU/h x 1000 - Cooling capacity indoor units: BTU/h x 1000

	1	2		3		
ELFO2-14	7	7+7	7+9	-		
	9	7+12	9+9			
	12	9+12	12+12			
ELFO2-18	7	7+7	7+9	-		
	9	7+12	9+9			
	12	9+12	12+12			
ELFO3-24	7	7+7	7+9	7+7+7	7+7+9	7+7+12
	9	7+12	7+18	7+7+18	7+9+9	7+9+12
	12	9+9	9+12	9+9+12	7+12+12	9+9+9
	18	9+18	12+12	-	-	-
	-	12+18	-	-	-	-









IDRA Potencia frigorífica de las unidades interiores: BTU/h x 1000 - Cooling capacity indoor units: BTU/h x 1000

	1	2			3			4		
IDRA2-18	7	7+7	7+9	7+12	-	-	-	-	-	-
	9	9+9	9+12	12+12	-	-	-	-	-	-
	12	-	-	-	-	-	-	-	-	-
IDRA3-24	7	7+7	7+9	7+12	7+7+7	7+7+9	7+7+12	-	-	-
	9	7+18	9+9	9+12	7+7+18	7+9+9	7+9+12	-	-	-
	12	9+18	12+12	12+18	7+12+12	9+9+9	9+9+12	-	-	-
	18	-	-	-	-	-	-	-	-	-
IDRA4-28	7	7+7	7+9	7+12	7+7+7	7+7+9	7+7+12	7+7+7+7	7+7+7+9	7+7+7+12
	9	7+18	9+9	9+12	7+7+18	7+9+9	7+9+12	7+7+9+9	7+7+9+12	7+9+9+9
	12	9+18	12+12	12+18	7+9+18	7+12+12	7+12+18	7+9+9+12	9+9+9+9	-
	18	18+18	-	-	9+9+9	9+9+12	9+9+18	-	-	-
	-	-	-	-	9+12+12	12+12+12	-	-	-	-
IDRA4-36	7	7+12	7+18	9+9	7+7+7	7+7+9	7+7+12	7+7+7+7	7+7+7+9	7+7+7+12
	9	9+12	9+18	12+12	7+7+18	7+9+9	7+9+12	7+7+7+18	7+7+9+9	7+7+9+12
	12	12+18	18+18	-	7+9+18	7+12+12	7+12+18	7+7+9+18	7+7+12+12	7+7+12+18
	18	-	-	-	7+18+18	9+9+9	9+9+12	7+9+9+9	7+9+9+12	7+9+9+18
	-	-	-	-	9+9+18	9+12+12	9+12+18	7+9+12+12	7+9+12+18	9+9+9+9
	-	-	-	-	9+18+18	12+12+12	12+12+18	9+9+9+12	9+9+9+18	9+9+12+12
	-	-	-	-	12+18+18	-	-	9+9+12+18	9+12+12+12	12+12+12+12

N.B.

- 1- En caso de funcionamiento simultáneo de las unidades interiores, la potencia máxima suministrada no puede superar la de la unidad condensadora.
- 1- In the case of contemporaneity in the use of indoor units, the maximum power delivered can not be higher than that of the condensing unit.
- 2- La capacidad total de las unidades interiores instalables no debe superar el 125% de la capacidad de la unidad condensadora.
- 2- The total capacity of the installable indoor units must not exceed 125% of the capacity of the condensing unit.
- 3- Para la versión H (Bomba de Calor), excluida IDRA Ring, las combinaciones resaltadas (fondo azul y en negrita) no se recomiendan.
- 3- For the H version (Heat Pump), excluding IDRA Ring, the highlighted combinations (blue background and bold) are not recommended.

ACCESORIOS PARA UNIDADES INTERIORES INDOOR UNITS ACCESSORIES

	Código Code	Descripción Description	Estándar Standard	Opcional Optional
	FILCATT	Filtro de carbón activo - Activated carbon filter	-	SKIV
	FILION	Filtro de iones de plata - Silver ion filter		
	FILHCHO	Filtro de purificación - Purification filter		
	FILTOUCH WI-FI	Control cableado táctil Wi-Fi Touch wire controller Wi-Fi	DUCT-V CASK-V CASK-CV	IMAGINE DBIS PLUS
	TELC	Control remoto con función IFEEL Remote Control with Ifeel function	SKIV	DBIS PLUS
	TELC2	Control remoto con función IFEEL Remote Control with Ifeel function	CASK-V CASK-CV CNS	CAIO DUCT-V DBIS PLUS
	TELC-I	Control remoto con función IFEEL Remote Control with Ifeel function	IMAGINE	-
	WI-FI SKY	Control del aire acondicionado a través de aplicación para smartphone (iOS y Android) con red Wi-Fi doméstica. Sólo para las series SKY y U.I. Air conditioner control via smartphone app (IOS and Android) with home Wi-Fi network. SKY and U.I. series only.	-	SKIV

SMART LIFE - APP PARA EL CONTROL WI-FI WI-FI CONTROL APP



La aplicación Smart Life (iOS y Android) ofrece opciones de control para tu dispositivo conectándolo a tu red Wi-Fi doméstica, para una interacción más fácil y agradable



The Smart Life app (iOS and Android) provides control options for your device by connecting it to your home Wi-Fi network, for easier and more enjoyable interaction.







ACCESORIOS PARA UNIDADES CONDENSADORAS CONDENSING UNIT ACCESSORIES

LOS INVISIBLES
THE INVISIBLES

COMPONENTES Y ACCESORIOS PARA LA INSTALACIÓN
COMPONENTS AND ACCESSORIES FOR INSTALLATION



	Código - Code	Descripción - Description
	AIRMS105	Soportes para unidad exterior. Peso soportado: 120 kg. Longitud: 440 mm (1 par). Brackets for Outdoor Unit. Supported weight: 120 Kg. Length 440 mm (1 pair).
	AIRMS402	Soportes para unidad exterior. Peso soportado: 250 kg. Longitud: 520 mm (1 par). Brackets for Outdoor Unit. Supported weight: 250 Kg. Length 520 mm (1 pair).
	AIRSP3	Bases de suelo. Longitud: 350 mm. Peso soportado: 140 kg (1 par). Floor bases. Length 350 mm. Supported weight: 140 Kg (1 pair).
	AIRSP4	Bases de suelo. Longitud: 450 mm. Peso soportado: 140 kg (1 par). Floor bases. Length 450 mm. Supported weight: 140 Kg (1 pair).
	TR-1408	Tubería de cobre aislada 1/4" - 0,8 mm. Rollo de 50 m. 1/4" - 0.8 mm insulated copper pipe. 50 m roll.
	TR-3808	Tubería de cobre aislada 3/8" - 0,8 mm. Rollo de 50 m. 3/8" - 0.8 mm insulated copper pipe. 50 m roll.
	TR-1208	Tubería de cobre aislada 1/2" - 0,8 mm. Rollo de 50 m. 1/2" - 0.8 mm insulated copper pipe. 50 m roll.
	TR-5810	Tubería de cobre aislada 5/8" - 1,0 mm. Rollo de 50 m. 5/8" - 1.0 mm insulated copper pipe. 50 m roll.

ANTIVIBRACIÓN
ANTIVIBRATION





	Código - Code	Descripción - Description
	AIRCAV101	Kit antivibración cónico M/M para soportes. Conical anti-vibration kit M/M for brackets.
	ACC11214	Kit antivibración cónico M para suelo. Conical anti-vibration kit M on the floor.
	SP10	Soportes para máquinas exteriores en polipropileno a prueba de golpes, autoextinguible y estabilizado contra los rayos UV. Completos con tuercas y pernos para la fijación de la máquina exterior. Se suministran con junta tórica para colocar en la parte inferior del soporte, lo que permite un mejor anclaje al suelo y una mayor absorción de vibraciones (4 piezas). Supports for external machines in shockproof, self-extinguishing and polypropylene stabilized against UV rays. Complete with nuts and bolts for fixing the external machine. Supplied with o-ring to be positioned in the lower part of the support for better anchoring to the ground and greater absorption of vibrations (4 pieces).
	AVS45-01	Bases de suelo de goma antivibración - Dimensiones: 450x160x90 mm (1 pieza). Rubber anti-vibration floor bases - Dimensions: 450x160x90 mm (1 piece).
	AVS60-01	Bases de suelo de goma antivibración - Dimensiones: 600x160x90 mm (1 pieza). Rubber anti-vibration floor bases - Dimensions: 600x160x90 mm (1 piece).

ACCESORIOS PARA UNIDADES DE CONDUCTOS DUCT UNITS ACCESSORIES

PLÉNUM PARA UNIDADES INTERIORES DE CONDUCTOS PLENUM FOR DUCTED INDOOR UNITS

	Código - Code	Descripción - Description	Modelo Model
	PLM-DBIS-09/12-1	Plénium de extensión con aislamiento exterior. Externally insulated extension plenum.	DUCT-09-V DUCT-12-V
	PLM-DBIS-09/12	Dim. 2 x Ø 155 mm. Plénium con aislamiento exterior. Dim. 2 x Ø 155 mm. Externally insulated plenum.	DUCT-09-V DUCT-12-V
	PLM-DBIS-18	Dim. 3 x Ø 155 mm. Plénium con aislamiento exterior. Dim. 3 x Ø 155 mm. Externally insulated plenum.	DUCT-18-V
	PLM-DBIS-24	Dim. 4 x Ø 155 mm. Plénium con aislamiento exterior. Dim. 4 x Ø 155 mm. Externally insulated plenum.	DUCT-24-V
	PLM-DBIS-36/48_4	Dim. 4 x Ø 200 mm. Plénium con aislamiento exterior. Dim. 4 x Ø 200 mm. Externally insulated plenum.	DUCT-36-V DUCT-48-V
	PLM-DBIS-36/48_6	Dim. 6 x Ø 155 mm. Plénium con aislamiento exterior. Dim. 6 x Ø 155 mm. Externally insulated plenum.	DUCT-36-V DUCT-48-V
	PLM-DBIS-12/18 PLUS	Dim. 3 x Ø 155 mm. Plénium con aislamiento exterior. Dim. 3 x Ø 155 mm. Externally insulated plenum.	DBIS-12 PLUS DBIS-18 PLUS

COMPONENTES DE DISTRIBUCIÓN DISTRIBUTION COMPONENTS

	Código - Code	Descripción - Description
	NASTELB	Cinta de tela altura 50 mm longitud 50 m. Cloth tape height 50 mm length 50 m.
	FLEX-160B	Dim. Ø 160 mm. Manguera de aluminio termoacústica. Pack de 10 m. Dim. Ø 160 mm. Thermophonic aluminum hose. 10 m pack.
	FLEX-200B	Dim. Ø 200 mm. Manguera de aluminio termoacústica. Pack de 10 m. Dim. Ø 200 mm. Thermophonic aluminum hose. 10 m pack.
	Y-151515	Derivación en Y de acero galvanizado. Diámetro: Ø150 mm. Y-shaped branch in galvanized steel. Diameters: Ø150 mm.
	FASC 60-270 B	Abrazadera de manguera de acero inoxidable, longitud ajustable de 60 a 270 mm. Stainless steel hose clamp, adjustable length from 60 to 270 mm.

REJILLAS DE ADMISIÓN CON FILTRO INTAKE GRILLES WITH FILTER

	Código - Code	Descripción - Description	Modelo Model
	RIPF-6030B	Dim. 600 x 300 mm. Aluminio anodizado. Rejilla de admisión con filtro. Dim. 600 x 300 mm. Anodized aluminum. Grid taken with filter.	DUCT-09-V DUCT-12-V
	RIPF-10030B	Dim. 1000 x 300 mm. Aluminio anodizado. Rejilla de admisión con filtro. Dim. 1000 x 300 mm. Anodized aluminum. Grid taken with filter.	DUCT-18-V DUCT-24-V DUCT-36-V DUCT-48-V

Pintura para RIPF en RAL 9010 o RAL 9016: +15 % sobre el precio de lista - Painting for RIPF in RAL 9010 or RAL 9016: +15% on the list price.

ACCESORIOS PARA UNIDADES DE CONDUCTOS DUCT UNITS ACCESSORIES

REJILLA DE AIRE

AIR GRILL

	Código - Code	Descripción - Description
	MAN-3015B	Rejillas de impulsión - Supply grilles. Dim. 300 x 150 mm.
	MAN-4015B	Rejillas de impulsión - Supply grilles. Dim. 400 x 150 mm.
	MAN-6015B	Rejillas de impulsión - Supply grilles. Dim. 600 x 150 mm.
	MAN-8015B	Rejillas de impulsión - Supply grilles. Dim. 800 x 150 mm.
	MAN-10015B	Rejillas de impulsión - Supply grilles. Dim. 1000 x 150 mm.
	MAN-4020B	Rejillas de impulsión - Supply grilles. Dim. 400 x 200 mm.
	MAN-5020B	Rejillas de impulsión - Supply grilles. Dim. 500 x 200 mm.
	MAN-6020B	Rejillas de impulsión - Supply grilles. Dim. 600 x 200 mm.
	MAN-7020B	Rejillas de impulsión - Supply grilles. Dim. 700 x 200 mm.
	MAN-8020B	Rejillas de impulsión - Supply grilles. Dim. 800 x 200 mm.
	MAN-10020B	Rejillas de impulsión - Supply grilles. Dim. 1000 x 200 mm.
	MANSC2-3015B	Rejilla de impulsión de techo con lamas ajustables en dos direcciones - Ceiling supply grille with adjustable louvers in two directions. Dim. 300 x 150 mm.
	MANSC2-3020B	Rejilla de impulsión de techo con lamas ajustables en dos direcciones - Ceiling supply grille with adjustable louvers in two directions. Dim. 300 x 200 mm.
	MANSC2-4010B	Rejilla de impulsión de techo con lamas ajustables en dos direcciones - Ceiling supply grille with adjustable louvers in two directions. Dim. 400 x 100 mm.

Pintura para MAN en RAL 9010 o RAL 9016: +15 % sobre el precio de lista - Painting for MAN in RAL 9010 or RAL 9016: +15% on the list price.



COMPUERTA PARA REJILLAS DE IMPULSIÓN

REGULATION DAMPERS

	Código - Code	Descripción - Description
	SERMAN-4010B	Compuerta de regulación para rejilla de impulsión - Adjustment damper for supply grille. Dim. 400 x 100 mm.
	SERMAN-3015B	Compuerta de regulación para rejilla de impulsión - Regulation damper for delivery grille. Dim. 300 x 150 mm.
	SERMAN-4015B	Compuerta de regulación para rejilla de impulsión - Regulation damper for delivery grille. Dim. 400 x 150 mm.
	SERMAN-4020B	Compuerta de regulación para rejilla de impulsión - Regulation damper for delivery grille. Dim. 400 x 200 mm.
	SERMAN-5020B	Compuerta de regulación para rejilla de impulsión - Regulation damper for delivery grille. Dim. 500 x 200 mm.

PLÉNEM PARA REJILLAS DE IMPULSIÓN

PLENUM FOR SUPPLY GRILLES

	Código - Code	Descripción - Description
	PL-301515B	Plénem de chapa metálica con aislamiento exterior para rejillas de impulsión y retorno. Dim. 300x150x200 - 1xØ150 conexión trasera. Externally insulated sheet metal plenum for supply and return grilles. Dim. 300x150x200 - 1xØ150 rear connection.
	PL-401515B	Plénem de chapa metálica con aislamiento exterior para rejillas de impulsión y retorno. Dim. 400x150x200 - 1xØ150 conexión trasera. Externally insulated sheet metal plenum for supply and return grilles. Dim. 400x150x200 - 1xØ150 rear connection.
	PL-601515B	Plénem de chapa metálica con aislamiento exterior para rejillas de impulsión y retorno. Dim. 600x150x200 - 2xØ150 conexión trasera. Externally insulated sheet metal plenum for supply and return grilles. Dim. 600x150x200 - 2xØ150 rear connection.
	PL-801515B	Plénem de chapa metálica con aislamiento exterior para rejillas de impulsión y retorno. Dim. 800x150x200 - 2xØ150 conexión trasera. Externally insulated sheet metal plenum for supply and return grilles. Dim. 800x150x200 - 2xØ150 rear connection.
	PL-1001515B	Plénem de chapa metálica con aislamiento exterior para rejillas de impulsión y retorno. Dim. 1000x150x200 - 3xØ150 conexión trasera. Externally insulated sheet metal plenum for supply and return grilles. Dim. 1000x150x200 - 3xØ150 rear connection.
	PL-402020B	Plénem de chapa metálica con aislamiento exterior para rejillas de impulsión y retorno. Dim. 400x200x200 - 1xØ200 conexión trasera. Externally insulated sheet metal plenum for supply and return grilles. Dim. 400x200x200 - 1xØ200 rear connection.
	PL-502020B	Plénem de chapa metálica con aislamiento exterior para rejillas de impulsión y retorno. Dim. 500x200x200 - 1xØ200 conexión trasera. Externally insulated sheet metal plenum for supply and return grilles. Dim. 500x200x200 - 1xØ200 rear connection.
	PL-602020B	Plénem de chapa metálica con aislamiento exterior para rejillas de impulsión y retorno. Dim. 600x200x200 - 2xØ200 conexión trasera. Externally insulated sheet metal plenum for supply and return grilles. Dim. 600x200x200 - 2xØ200 rear connection.
	PL-702020B	Plénem de chapa metálica con aislamiento exterior para rejillas de impulsión y retorno. Dim. 700x200x200 - 2xØ200 conexión trasera. Externally insulated sheet metal plenum for supply and return grilles. Dim. 700x200x200 - 2xØ200 rear connection.
	PL-802020B	Plénem de chapa metálica con aislamiento exterior para rejillas de impulsión y retorno. Dim. 800x200x200 - 2xØ200 conexión trasera. Externally insulated sheet metal plenum for supply and return grilles. Dim. 800x200x200 - 2xØ200 rear connection.
	PL-1002020B	Plénem de chapa metálica con aislamiento exterior para rejillas de impulsión y retorno. Dim. 1000x200x200 - 2xØ200 conexión trasera. Externally insulated sheet metal plenum for supply and return grilles. Dim. 1000x200x200 - 2xØ200 rear connection.
	PLS-401010B	Plénem de chapa metálica con aislamiento exterior para rejillas de impulsión y retorno. Dim. 400x100x220 - 1xØ100 conexión lateral 90°. Externally insulated sheet metal plenum for supply and return grilles. Dim. 400x100x220 - 1xØ100 side connection 90°.
	PLS-401510B	Plénem de chapa metálica con aislamiento exterior para rejillas de impulsión y retorno. Dim. 400x150x220 - 1xØ100 conexión lateral 90°. Externally insulated sheet metal plenum for supply and return grilles. Dim. 400x150x220 - 1xØ100 side connection 90°.
	PLS-301515B	Plénem de chapa metálica con aislamiento exterior para rejillas de impulsión y retorno. Dim. 300x150x270 - 1xØ150 conexión lateral 90°. Externally insulated sheet metal plenum for supply and return grilles. Dim. 300x150x270 - 1xØ150 side connection 90°.
	PLS-401515B	Plénem de chapa metálica con aislamiento exterior para rejillas de impulsión y retorno. Dim. 400x150x270 - 1xØ150 conexión lateral 90°. Externally insulated sheet metal plenum for supply and return grilles. Dim. 400x150x270 - 1xØ150 side connection 90°.
	PLS-302020B	Plénem de chapa metálica con aislamiento exterior para rejillas de impulsión y retorno. Dim. 300x200x320 - 1xØ200 conexión lateral 90°. Externally insulated sheet metal plenum for supply and return grilles. Dim. 300x200x320 - 1xØ200 side connection 90°.
	PLS-502020B	Plénem de chapa metálica con aislamiento exterior para rejillas de impulsión y retorno. Dim. 500x200x320 - 1xØ200 conexión lateral 90°. Externally insulated sheet metal plenum for supply and return grilles. Dim. 500x200x320 - 1xØ200 side connection 90°.

ACCESORIOS PARA UNIDADES DE CONDUCTOS DUCT UNITS ACCESSORIES

DIFUSORES LINEALES LINEAR AIR DIFFUSERS

Difusor lineal, 2 ranuras con deflectores orientables. Fabricado en aluminio anodizado extruido, deflector negro en polipropileno RAL 9005. Se utilizan en techo, tanto en impulsión como en retorno, a una altura de instalación de 2,5-3,1 m. Fijación mediante tornillos frontales con soporte interior móvil. Accesorio: plénum de conexión en acero galvanizado con aislamiento.

Linear diffuser, 2 slits with drop deflectors. Made of extruded anodized aluminum, RAL 9005 black deflector in polypropylene. They are used on the ceiling, in supply and return at an installation height of 2.5-3.1 m. Fixing by front screws with internal movable bracket. Accessory: galvanized steel connection plenum with insulation.

	Código - Code	Descripción - Description
	TPDL2-1000	Dim. L. 1000 mm Difusor lineal, 2 ranuras con deflectores orientables. Dim. L. 1000 mm Linear diffuser, 2 slits with drop deflectors.
	TPDL2-1500	Dim. L. 1500 mm Difusor lineal, 2 ranuras con deflectores orientables. Dim. L. 1500 mm Linear diffuser, 2 slits with drop deflectors.

PLÉNEM PARA REJILLAS DE IMPULSIÓN PLENUM FOR SUPPLY GRILLES

	Código - Code	Descripción - Description
	TPPDLI3-2/1	Dim. 1000 mm - 1 conexión 160 mm. Plénum de conexión en acero galvanizado con aislamiento. Dim. 1000 mm - 1 connection 160 mm. Galvanized steel connection plenum with insulation.
	TPPDLI3-2/2	Dim. 1500 mm - 2 conexiones 160 mm. Plénum de conexión en acero galvanizado con aislamiento. Dim. 1500 mm - 2 connection 160 mm. Galvanized steel connection plenum with insulation.

Solución de continuidad Continuity solution

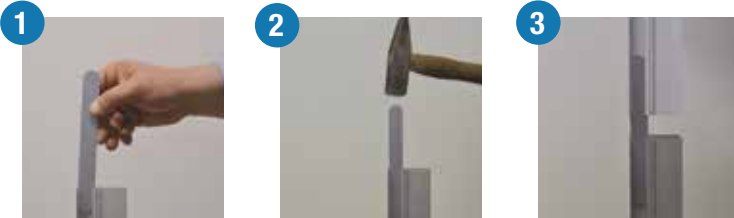

1 Insertar la escuadra en el perfil en el sentido indicado

Insert the bracket in the profile in the direction shown



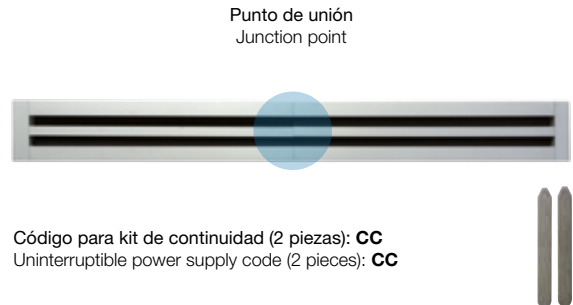

2 Insertar la escuadra hasta que el punto de bloqueo penetre 10/15 mm

Insert the bracket until the locking point penetrates 10/15 mm

3 Una los 2 elementos
Join the 2 elements



Código para kit de continuidad (2 piezas): **CC**
Uninterruptible power supply code (2 pieces): **CC**

Código - Code	TPDL2-....1	TPDL2-....2	TPDL2-....3	TPDL2-....4
Descripción - Description	Difusor - Diffuser		Plenum - Plenum	
	Estándar, para la toma de aire Standard, for air intake	Con deflector, para la impulsión de aire With deflector, for air delivery	No aislado, para la toma de aire Not isolated, for air intake	Aislado, para la impulsión de aire Insulated, for air delivery
TPDL2-1000				
TPDL2-1500				

	Ø Collarín ext. ext. collar	Anchura parte superior W upper part mm	Anchura con ganchos W with hooks mm	Anchura difusor W diffuser mm	Altura del difusor H diffuser mm	A _s [m²]	Q [m³/h]		L _{wa} [dB(A)]		X [m]	
							min	max	min	max	min	max
TPDL2-1000	148-2	78	89	115	60	0,02073	240	550	30	49	5,0	11,8
TPDL2-1500	148-3											

ACCESORIOS PARA UNIDADES DE CONDUCTOS DUCT UNITS ACCESSORIES

KIT DE DISTRIBUCIÓN PARA UNIDADES CANALIZADAS CON DIFUSORES LINEALES

DISTRIBUTION KIT FOR DUCTED UNITS WITH LINEAR DIFFUSERS

De 1 a 6 habitaciones
From 1 to 6 rooms

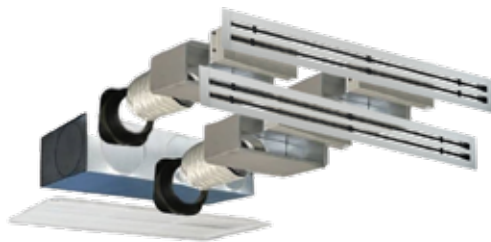

Código del kit Kit code	Modelo Model	Nº de zonas	Rejilla de retorno Return grille		Plénium de impulsión Supply Plenum				Nº de abrazaderas No. Clamps	Tubo flexible Flexible duct	Caja de calma Plenum box	Difusores lineales Linear diffusers
			ripf-6030B	ripf-10030B	pim-dbis-9/12	pim-dbis-18	pim-dbis-24	pim-dbis-36/48 - 6 x 160				
	Unidad interior de climatización indoor unit climate								fasc 60-270b	flex 160b - 10 metri	TPPDLI3-2/1	TPDL2-1000
KIT DBIS-DIFF-9/2	DUCT-09-V	2	1		1				4	1	2	2
KIT DBIS-DIFF-12/2*	DUCT-12-V	2	1		1				4	1	2	2
KIT DBIS-DIFF-18/2*	DUCT-18-V	2		1		1			4	1	2	2
KIT DBIS-DIFF-18/3*		3		1		1			6	1	3	3
KIT DBIS-DIFF-24/2	DUCT-24-V	2		1			1		4	1	2	2
KIT DBIS-DIFF-24/3		3		1			1		6	1	3	3
KIT DBIS-DIFF-24/4		4		1			1		8	1	4	4
KIT DBIS-DIFF-36/3	DUCT-36-V	3		1				1	6	1	3	3
KIT DBIS-DIFF-36/4		4		1			1		8	1	4	4
KIT DBIS-DIFF-36/5		5		1			1		10	1	5	5
KIT DBIS-DIFF-36/6		6		1			1		12	1	6	6
KIT DBIS-DIFF-48/3	DUCT-48-V	3		1				1	6	1	3	3
KIT DBIS-DIFF-48/4		4		1			1		8	1	4	4
KIT DBIS-DIFF-48/5		5		1			1		10	1	5	5
KIT DBIS-DIFF-48/6		6		1			1		12	1	6	6

* Disponible también para U.I. DBIS PLUS 12-18.

* Available also for I.U. DBIS PLUS 12-18.

ACCESORIOS PARA UNIDADES DE CONDUCTOS DUCT UNITS ACCESSORIES

LOS INVISIBLES
THE INVISIBLES

DIFUSORES LINEALES
LINEAR AIR DIFFUSERS

Ejemplos de instalación - Installation examples

En este salón se decidió eliminar un antiestético sistema de aire acondicionado de ventana. El apartamento en cuestión tenía la vista principal al gran parque de la ciudad completamente obstruida por el climatizador: con la instalación de un sistema canalizado mediante difusores lineales, se liberó el hueco, logrando un aumento significativo de la luminosidad de la estancia y una mejora notable en el diseño del salón.

In this living room it was decided to eliminate an unsightly window air conditioning system. The apartment in question had the main view of the large city park completely obstructed by the air conditioner: with the installation of a ducted system through linear diffusers, the fixture was freed with a significant increase in the brightness of the room and a significant improvement in the design of the living room.



La cocina de esta vivienda, antes equipada con un par de difusores lineales, tenía dos splits murales prácticos pero voluminosos. Debido a los vapores procedentes de la cocina, los filtros de las dos máquinas se bloqueaban con frecuencia, lo que generaba un mantenimiento continuo. ¡Problema resuelto con la instalación de difusores a lo largo de la pared izquierda!

The kitchen of this house, before a pair of linear diffusers, had two practical but bulky wall splits. Due to the vapors coming from the stove, the filters of the two machines were frequently blocked and this was a reason for continuous maintenance. Problem solved with the installation of speakers along the left wall!



Los difusores para canalización son la primera elección para arquitectos y diseñadores, ya que ofrecen el máximo nivel de discreción estética. Todo lo que es visible es una pequeña abertura de pocos centímetros en la pared o a lo largo del techo: el marco alrededor del difusor queda completamente oculto detrás del enlucido, ofreciendo un beneficio único que otros sistemas de climatización no pueden proporcionar.

Ducted diffusers are the first choice for architects and designers as they offer the highest level of aesthetic discretion. All that is visible is a small opening, just a few centimeters wide, in the wall or along the ceiling: the frame around the diffuser is completely hidden behind the plaster, providing a unique advantage that other air conditioning systems cannot offer.



SOBRE LA ZONIFICACIÓN

ABOUT ZONING

¿QUÉ SE ENTIENDE POR KIT DE ZONIFICACIÓN?

WHAT IS MEANT BY A ZONING KIT?

Un **kit de zonificación** es un sistema que permite el control independiente de la **temperatura en diferentes áreas o “zonas”** dentro de un edificio, mejorando el confort y optimizando la eficiencia energética.

A **zoning kit** is a system that allows for independent **temperature control in different areas or “zones”** within a building, enhancing comfort and optimizing energy efficiency.

Funcionamiento del kit de zonificación

Operation of the Zoning Kit

El kit de zonificación suele basarse en una serie de válvulas o compuertas motorizadas que regulan el flujo de aire hacia cada zona en función de la temperatura establecida en un termostato dedicado o en un sistema de control centralizado. Los principales componentes de un kit de zonificación son: **compuertas motorizadas, termostatos de zona y una unidad de control.**

The zoning kit typically relies on a series of motorized valves or dampers that regulate the airflow to each zone based on the temperature set on a dedicated thermostat or a centralized control system. The main components of a zoning kit are: **motorized dampers, zone thermostats, and a control unit.**

Funcionamiento del kit de zonificación

Operation of the Zoning Kit

- **Ahorro energético:** evitan climatizar zonas desocupadas.
- **Confort personalizado:** permite a los ocupantes de diferentes áreas de un edificio ajustar la temperatura según sus preferencias.
- **Eficiencia del sistema:** reduce el desperdicio y optimiza el funcionamiento del sistema de climatización, prolongando su vida útil.
- **Energy savings:** they prevent heating or cooling unoccupied areas.
- **Customized comfort:** allows occupants of different areas of a building to adjust the temperature according to their preferences.
- **System efficiency:** reduces waste and optimizes the operation of the HVAC system, extending its lifespan.

KIT DE ZONIFICACIÓN ZONING KIT

KIT OPAL

OPAL KIT



Opal es un sistema de regulación que puede combinarse con los sistemas de distribución de aire residenciales, permitiendo comandos proporcionales para modular el flujo de aire en varias zonas de la vivienda. El sistema consta de una unidad de control que recibe los datos de temperatura de los termostatos suministrados a través de radio para las diferentes estancias y posteriormente actúa sobre la apertura o cierre de los actuadores compuestos por las compuertas de regulación. OPAL IOT puede supervisar y controlar todas las zonas tanto localmente como de forma remota vía Wi-Fi mediante una APP dedicada. Esta familia de productos se caracteriza por su facilidad de instalación y uso.

Opal is a regulation system that can be paired with residential air distribution systems, allowing for proportional commands to modulate airflow in various zones of the home. The system consists of a control unit that receives temperature data from the provided thermostats via radio for the different rooms and subsequently acts on the opening or closing of the actuators made up of the regulating dampers. OPAL IoT can monitor and control all zones both locally and remotely via Wi-Fi using a dedicated APP. This product family is characterized by ease of installation and use.

KIT OPAL PARA SISTEMA DE CONTROL MULTIZONA

OPAL KIT FOR MULTI-ZONE CONTROL SYSTEM

De 2 a 5 habitaciones
From 2 to 5 rooms



Código del kit Kit code	Nº de zonas	Centralita inalámbrica Wireless control unit	Motor By Pass By pass motor	Kit de regulación Regulation kit	Compuertas circulares Circular Shutters	
		OPAL C-210	C-210-BP	OPAL RF PRO 680	SER150	
KIT OPAL 2	2	1	1	2	3	2 compuertas + 1 bypass 2 shutters + 1 bypass
KIT OPAL 3	3	1	1	3	4	3 compuertas + 1 bypass 3 shutters + 1 bypass
KIT OPAL 4	4	1	1	4	5	4 compuertas + 1 bypass 4 shutters + 1 bypass
KIT OPAL 5	5	1	1	5	6	5 compuertas + 1 bypass 5 shutters + 1 bypass

KIT OPAL IOT PARA REGULACIÓN ELECTRÓNICA MULTIZONA WI-FI

OPAL IOT KIT FOR MULTI-ZONE CONTROL SYSTEM WI-FI

De 2 a 5 habitaciones
From 2 to 5 rooms



Código del kit Kit code	Nº de zonas	Centralita inalámbrica Wireless control unit	Motor By Pass By pass motor	Kit de regulación Regulation kit	Compuertas circulares Circular Shutters		Gateway Wi-Fi
		OPAL ZC-208 DK IOT	C-210-BP	OPAL 690 IOT	SER150		HUB
KIT OPAL 2 - WI-FI	2	1	1	2	3	2 compuertas + 1 bypass 2 shutters + 1 bypass	1
KIT OPAL 3 - WI-FI	3	1	1	3	4	3 compuertas + 1 bypass 3 shutters + 1 bypass	1
KIT OPAL 4 - WI-FI	4	1	1	4	5	4 compuertas + 1 bypass 4 shutters + 1 bypass	1
KIT OPAL 5 - WI-FI	5	1	1	5	6	5 compuertas + 1 bypass 5 shutters + 1 bypass	1

KIT DE ZONIFICACIÓN ZONING KIT

COMPONENTES KIT OPAL

KIT OPAL COMPONENTS

	Código - Code	Descripción - Description	Modelo Model
	OPAL C-210	Centralita inalámbrica C210. Controla hasta 5 zonas con termostatos ambiente inalámbricos y además gestiona la compuerta de bypass motorizada. Wireless control unit C210. Controls up to 5 zones with room radio thermostats and also manages the motorized by-pass damper.	OPAL
	C-210-BP	Motor By-pass. Motor para compuerta de by-pass, completo con cable RJ11 de 6 metros. By-pass motor. Motor for by-pass damper, complete with 6-meter RJ11 cable.	OPAL
	IOT-BP	Motor By-pass. Motor para compuerta de by-pass, completo con cable RJ45 de 6 metros. By-pass motor. Motor for by-pass damper, complete with 6-meter RJ45 cable.	OPAL IOT
	OPAL RF PRO 680	Kit de regulación. Termostato ambiente electrónico inalámbrico, con comunicación por radio hasta 30 m, completo con motor para compuerta y cable de conexión RJ45 de 3 metros. Adjustment kit. Proportional electronic room thermostat with radio communication up to 30 meters, complete with damper motor and 3-meter-long RJ45 connection cable.	OPAL
	SER150	Compuertas circulares 150 mm - 6" - Circular dampers 150 mm - 6"	OPAL OPAL IOT
	SER200	Compuertas circulares 200 mm - 6" - Circular dampers 200 mm - 6"	
	OPAL ZC-208	Centralita inalámbrica ZC-208 DK. Controla hasta 6 zonas con termostatos ambiente inalámbricos y además gestiona la compuerta de by-pass motorizada. Compatible con Gateway Wi-Fi para la gestión remota mediante App. Wireless control unit ZC-208 DK. Controls up to 6 zones with room radio thermostats and also manages the motorized by-pass damper. Can be paired with a Wi-Fi gateway for remote management via app.	OPAL IOT
	OPAL 690 IOT	Kit de regulación. Termostato ambiente electrónico inalámbrico para ZC-208 DK, con comunicación por radio hasta 30 m, completo con motor para compuerta y cable de conexión RJ45 de 3 metros. Adjustment kit. Electronic room radio thermostat for ZC-208 DK with radio communication up to 30 m, complete with damper motor and 3-meter RJ45 connection cable.	OPAL IOT
	HUB	Gateway Wi-Fi. Permite la conexión a internet y la gestión mediante APP para el monitoreo y el control de cada zona instalada en el sistema. Wi-Fi gateway. Enables internet connection and app-based management for monitoring and controlling each zone installed in the system.	OPAL IOT

KIT DE ZONIFICACIÓN ZONING KIT

KIT AIRZONE

AIRZONE KIT



La gestión por zonas permite segmentar la climatización de un edificio en áreas autónomas, adaptándola a las características específicas y a las necesidades de cada ambiente. Flexa 25 Circular coordina el sistema de climatización por conductos con la calefacción por suelo radiante y con los radiadores, utilizando algoritmos exclusivos para optimizar el confort de los usuarios y minimizar el consumo energético del sistema.

Zoned management allows building climate control to be divided into autonomous areas, adapting it to the specific characteristics and needs of each environment. Flexa 25 Circular coordinates the ducted air conditioning system with radiant floor heating and radiators, using exclusive algorithms to optimize user comfort and minimize the system's energy consumption.

KIT AIRZONE FLEXA WI-FI

KIT AIRZONE FLEXA Wi-Fi

De 2 a 8 estancias
From 2 to 8 rooms



Código Kit code	Num. zone	Flexa 25 Circular, Webservice cloud HUB, sensore AirQ Flexa 25 Circular, Webservice Cloud HUB, AirQ sensor.	Termostato Airzone Think Airzone Thermostat Think	Compuerta circular motorizada de 150 mm con ionizador 150mm Motorized Circular Shutter with ionization	Bypass circular 150 mm 150 mm Circular Bypass
		AZC25PCB1AQCW	AZCE6THINKRB	CPC150MTEION	BYCI150
KIT AIRZONE 2 WIFI	2	1	2	2	1
KIT AIRZONE 3 WIFI	3	1	3	3	1
KIT AIRZONE 4 WIFI	4	1	4	4	1
KIT AIRZONE 5 WIFI	5	1	5	5	1
KIT AIRZONE 6 WIFI	6	1	6	6	1
KIT AIRZONE 7 WIFI	7	1	7	7	1
KIT AIRZONE 8 WIFI	8	1	8	8	1

KIT DE ZONIFICACIÓN ZONING KIT

COMPONENTES FLEXA 25 CIRCULAR FLEXA 25 CIRCULAR COMPONENTS

	Código - Code	Descripción - Description
	AZC25PCB1AQCW	Pack Airzone compuesto por placa central Flexa 25 Circular, servidor web cloud HUB, sensor AirQ y cable bus de 15 metros. Airzone pack consisting of Flexa 25 Circular central board, Webserver Cloud HUB, AirQ sensor, and 15-meter bus cable.
	AZCE6BLUEZEROCB	Termostato Airzone Blueface Zero con cable blanco 8Z. El termostato Airzone Blueface dispone de una pantalla capacitiva a color y una interfaz gráfica. Es el termostato más completo y ofrece todas las posibilidades de control y configuración de los sistemas Airzone. Airzone Blueface Zero Wired Thermostat 8Z. The Airzone Blueface thermostat features a color capacitive touchscreen and a graphical interface. It is the most comprehensive thermostat and offers all control and configuration options for Airzone systems.
	AZCE6THINKRB	Termostato monocromático Airzone Think inalámbrico blanco 8Z. El termostato Airzone Think está equipado con una pantalla gráfica electrónica E-ink y botones capacitivos para el control de la zona. Se trata de una tecnología que prioriza el bajo consumo energético para una larga duración de la batería, ofreciendo al mismo tiempo amplias opciones de control. Airzone Think Monochrome Radio Thermostat White 8Z. The Airzone Think thermostat features an E-ink electronic graphic display and capacitive buttons for zone control. This technology prioritizes low energy consumption for a long battery life while providing extensive control options.
	BYCI150	Bypass circular 150 mm. Circular Bypass 150 mm.
	BYCI200	Bypass circular 200 mm. Circular Bypass 200 mm.
	CPCC150MTEION	Compuerta circular Airzone motorizada de 150 mm con ionización. Motorized 150 mm circular Airzone damper with ionization.
	CPCC200MTEION	Compuerta circular Airzone motorizada de 200 mm con ionización. Motorized 200 mm circular Airzone damper with ionization.
	AZX6CABLEBUS15	Cable de conexión (2x0,5 + 2x0,22) 15 m. Connection Cable (2x0.5 + 2x0.22) 15 m.
	AZX6CABLEBUS100	Cable de conexión (2x0,5 + 2x0,22) 100 m. Connection Cable (2x0.5 + 2x0.22) 100 m.

KIT DE ZONIFICACIÓN ZONING KIT

KIT MADEL MADEL KIT

MADEL®

La gestión por zonas permite segmentar la climatización de un edificio en áreas autónomas, adaptándola a las características específicas y a las necesidades de cada ambiente. La nueva **Zity 2.0-RC**, combinada con el nuevo **TeknoBox**, permite un innovador control mediante **Modbus** de las unidades canalizadas Tekno Point.

Zone control enables the segmentation of a building's air conditioning system into independent areas, allowing it to be tailored to the specific characteristics and requirements of each space.

The new **Zity 2.0-RC**, combined with the new TeknoBox, provides innovative **Modbus** control of Tekno Point ducted units.

KIT MADEL WI-FI MADEL KIT WI-FI

De 2 a 6 estancias
From 2 to 6 rooms



Código Kit code	Num. zone	Central de control Radio control unit	Gateway Modbus	Termostato Thermostat	Compuerta circular motorizada 150 mm 150mm Motorized Circular Shutter	Bypass circular 150 mm 150 mm Circular Bypass	Webserver Madel cloud Wi-Fi
		ZITY-RC 2.0	TEKNOBOX	ZEUS-HC/B	ZC 150	ZS 250 150	NETBOX
KIT MADEL 2	2	1	1	2	2	1	-
KIT MADEL 2 WIFI	2	1	1	2	2	1	1
KIT MADEL 3	3	1	1	3	3	1	-
KIT MADEL 3 WIFI	3	1	1	3	3	1	1
KIT MADEL 4	4	1	1	4	4	1	-
KIT MADEL 4 WIFI	4	1	1	4	4	1	1
KIT MADEL 5	5	1	1	5	5	1	-
KIT MADEL 5 WIFI	5	1	1	5	5	1	1
KIT MADEL 6	6	1	1	6	6	1	-
KIT MADEL 6 WIFI	6	1	1	6	6	1	1

ZSMARTBOX



Kit de zonificación Plug&Play compuesto por un plenum de máquina aislado y motorizado PLZON, la electrónica de control (central + termostatos) suministrada ya cableada y configurada, lista para su instalación. Disponible tanto en versión inalámbrica como cableada. Según el modelo DUCT-V seleccionado, es posible solicitar el zmartbox de 2 hasta 5 zonas.

Plug & Play zoning kit consisting of an insulated and motorized PLZON unit plenum and the control electronics (control unit + thermostats), supplied pre-wired and pre-configured, ready for installation. Available in both wireless and wired versions. Depending on the selected DUCT-V model, the Zmartbox can be ordered in configurations from 2 up to 5 zones.

KIT DE ZONIFICACIÓN ZONING KIT

COMPONENTES KIT MADEL KIT MADEL COMPONENTS

	Código - Code	Descripción - Description
	ZITY-RC 2.0	Central de control inalámbrica para sistemas de climatización y calefacción de 2 a 6 zonas. Radio control unit for air conditioning and heating systems with 2 to 6 zones.
	ZITY-W 2.0	Central de control cableada para sistemas de climatización y calefacción de 2 a 6 zonas. Wired control unit for air conditioning and heating systems with 2 to 6 zones.
	ZEUS-HC/B	Termostato digital con pantalla e-ink de bajo consumo, comunicación radio bidireccional, funciona en combinación con las centrales del sistema Zoning. Disponible en dos colores: blanco o negro. Digital thermostat with low-power e-ink display and bidirectional radio communication, designed to operate in combination with Zoning system control units. Available in two colors: white or black.
	ZEBRA-B	Cronotermostato digital cableado (W), para combinar con la plataforma de control Zity. Comunicación bidireccional entre la central Zity y el termostato. Integración del modo Master/Slave en el mismo termostato. Programación semanal a 2 niveles: Comfort/ECO. Permite una configuración adaptada a cada instalación, el bloqueo de funciones, la limitación de las temperaturas de consigna, etc. Wired (W) digital programmable thermostat, to be paired with the Zity control platform. Bidirectional communication between the Zity control unit and the thermostat. Integrated Master/Slave mode within the same thermostat. Two-level weekly programming: Comfort/ECO. Allows system-specific configuration, function locking, setpoint temperature limitation, and more.
	TEKNOBOX	Interfaz para unidades Tekno Point. Gateway de comunicación Modbus entre las centrales Zoning y las unidades canalizables DUCT-V. Interface for Tekno Point units. Modbus communication gateway between Zoning control units and DUCT-V ducted units.
	NETBOX	Interfaz de comunicación Cloud entre la central ZITY y la aplicación Zoning 2.0 disponible en App Store y Google Play. Cloud communication interface between the ZITY control unit and the Zoning 2.0 application, available on the App Store and Google Play.
	ZC 150	Compuerta circular motorizada (24V) para sistema de zonificación. Cierre estanco, fabricada en acero galvanizado, con rodamientos y junta de goma. Instalación en conductos Ø150 mm. Motorized circular damper (24V) for zoning systems. Airtight closure, made of galvanized steel, with bearings and rubber gasket. Suitable for installation on Ø150 mm ducts.
	ZC 200	Compuerta circular motorizada (24V) para sistema de zonificación. Cierre estanco, fabricada en acero galvanizado, con rodamientos y junta de goma. Instalación en conductos Ø200 mm. Motorized circular damper (24V) for zoning systems. Airtight closure, made of galvanized steel, with bearings and rubber gasket. Suitable for installation on Ø200 mm ducts.
	ZS 250 150	Compuerta de sobrepresión regulable. Adjustable pressure relief damper.

NEW



El modelo más pequeño del mercado; no solo compacto, sino también silencioso y económico. Disponible en dos tamaños de 3,6 kW y 5,3 kW en la versión solo frío. Puede instalarse fácilmente en un armario o debajo del fregadero en la cocina, en baño o en cualquier pequeño espacio sin uso.



The smallest model on the market; not only compact but also silent and economical. Available in two sizes of 3.6 kW and 5.3 kW in the cooling only version. It can be easily installed in a cabinet or under the sink in the kitchen, bathroom or any small unused space.

PICCOLO MONOSPLIT

UNIDAD CONDENSADORA COMPACTA AGUA-AIRE OCULTA
INVISIBLE COMPACT WATER COOLED CONDENSING UNIT



Unidad mural propia
Own wall mounted unit



PIC-09C | PIC-12C | PIC-18C



Mando a distancia incluido
Standard remote control

Solo frío - Cooling only

PICCOLO 09
PICCOLO 12

PICCOLO 18

PICCOLO MONOSPLIT

CLIMATIZADOR INVISIBLE AGUA-AIRE ON-OFF

INVISIBLE WATER-TO-AIR ON-OFF CONDENSING UNIT



PICCOLO Monosplit solo frío - Monosplit cooling only						
Código del kit - Set code		Cod.	PICCOLO 09	PICCOLO 12	PICCOLO 18	
Unidad Interior - Indoor Unit		Cod.	PIC-09C6(I)	PIC-12C6(I)	PIC-18C6(I)	
Unidad condensadora - Condensing unit		Cod.	PIC-09C	PIC-12C	PIC-18C	
Alimentación - Power Supply		V-Hz-Ph	230-50-1	230-50-1	230-50-1	
Protección contra sobrecorriente - Max Overcurrent Protection		A	16	16	25	
Sección de cables de alimentación - Power cable cross-sectional area		mm ²	1,5	1,5	2,5	
Refrigeración Cooling	Potencia Capacity	Nominal	W/BTU	2700/9300	3600/12000	5300/18000
	Consumo eléctrico Max power absorbtion	Nominal	W	634	900	1300
	EER		W/W	4,04	4,0	4,08
Clase energética - Energy class			-	A	A	A
Presión sonora - Sound level				43	46	47
Potencia sonora - Sound power				53	57	58
Método de regulación - Throttling method			-	Capillare - Capillary	Capillare - Capillary	Capillare - Capillary
Dimensiones - Dimensions (LxPxH)			mm	400x230x432	405x235x432	405x235x432
Peso - Weight			Kg		20	30
Compresor - Compressor			Marca	Landa	Panasonic	Panasonic
Refrigerante Refrigerant	Tipo - Type		-	R32	R32	R32
	Precarga - Precharge		Kg	0,75	0,85	1,10
	Carga adicional - Add. Charge		gr/m	12	20	30
Tuberías frigoríficas Refrigeration piping	Dimensiones - Dimensions		inch	1/4" - 3/8"	1/4"-3/8"	1/4"-1/2"
	Distancia máxima con precarga Max distance with pre-charge		m	5	5	5
	Distancia máxima permitida entre unidades Max allowable distance between units		m	15	10	15
	Desnivel máximo entre unidades Max elevation difference between units		m	5	5	5
Conexiones de agua - Water connections			inch	3/8"	3/8"	1/2"
Presión óptima del agua de entrada - Optimal inlet water pressure			bar	2,0 - 2,5	1,5 - 2,0	1,5 - 2,0
Consumo de agua - Use of water	Refrigeración - Cooling		L/h	0,08	105	150
	Límites de funcionamiento Operating limits	Agua de entrada - Inlet Water	°C	+8~+20	+8~+20	+8~+20
Temperatura ajustable Set temperature range	Unidad Interior - Indoor Unit		°C	+16~+31	+16~+31	+16~+31
Caudal de aire UI - Air flow IU			m ³ /h	660/540/460/330	660/540/460/330	800/720/610/520
Presión sonora UI - Sound level IU			dB(A)	42	42	44
Potencia sonora UI - Sound power IU			dB(A)	53	53	55
Dimensiones UI - IU Dimensions (LxPxH)			mm	790x275x195	790x275x195	965x302x222
Peso UI - IU Weight			Kg	11,5	11,5	14,5

N.B.: la normativa no exige SEER y SCOP para las unidades agua-aire | The regulations do not require SEER and SCOP for water-to-air units.

Condiciones de prueba temperatura del agua de entrada: 15 °C.
Refrigeración: int. 27°C B.S.

Test conditions inlet water temperature: 15°C.
Cooling: int. 27°C D.B.



Tekno Point presenta **CAIO**, el monobloque canalizado condensado por agua con el que amplía su oferta hacia interlocutores comerciales de múltiples sectores, incluidos los de la construcción, restauración y mantenimiento, ofreciendo una solución completamente oculta a la vista y de fácil instalación. **CAIO** ofrece excelentes prestaciones en climatización estival y un alto rendimiento en bomba de calor, situándose en la clase energética A++/A+. Altas prestaciones también en términos de presión disponible, permitiendo al proyectista diseñar canalizaciones más largas y versátiles.

Tekno Point introduce **CAIO**, the water-cooled ducted monobloc unit designed to expand its offering to commercial partners across multiple sectors, including construction, renovation, and maintenance. It provides a fully concealed, easy-to-install solution for those seeking minimal visual impact. **CAIO** delivers excellent summer cooling performance and high efficiency in heat pump mode, achieving an A++/A+ energy rating. It also offers strong static pressure performance, enabling designers to plan longer and more versatile ducting layouts.

DÓNDE INSTALAR CAIO WHERE TO INSTALL CAIO



Instalación en un falso techo
Installation in a suspended ceiling



Instalación en un mueble de cocina
Installation in a kitchen cabinet



Instalación en un desván
Installation in the attic



Instalación en un pasillo
Installation in the corridor

Clasificación energética de los climatizadores agua-aire Energy classification of water-air conditioners

	EER		COP
A+++	≥ 8,50	A+++	≥ 5,10
A++	≥ 6,10	A++	≥ 4,60
A+	≥ 5,10	A+	≥ 4,00
B	≥ 4,60	B	≥ 3,10
C	≥ 4,10	C	≥ 2,80
D	≥ 3,60	D	≥ 2,50
E	≥ 3,10	E	≥ 2,20
F	≥ 2,60	F	≥ 1,90
G	≥ 2,60	G	> 1,90



VENTAJAS

El climatizador compacto condensado por agua:

- Sin unidad exterior
- Sin perforaciones en la pared exterior
- Instalación sencilla
- Sin conexión frigorífica
- No requiere certificación F-Gas
- Posibilidad de emisión directa de aire o canalización hacia varias estancias
- Bajo nivel sonoro
- Conectable vía Wi-Fi
- Excelente rendimiento en climatización estival
- Alta eficiencia en modo bomba de calor

ADVANTAGES

The water-cooled packaged air conditioner:

- No external unit
- No holes in the outer wall
- Easy installation
- No refrigerant connection
- No FGas certification required
- Possibility of direct air emission or ducting to several rooms
- Low noise level
- Connectable via wifi
- Excellent performance in summer air conditioning
- High efficiency in heat pump

DATOS TÉCNICOS TECHNICAL DATAS

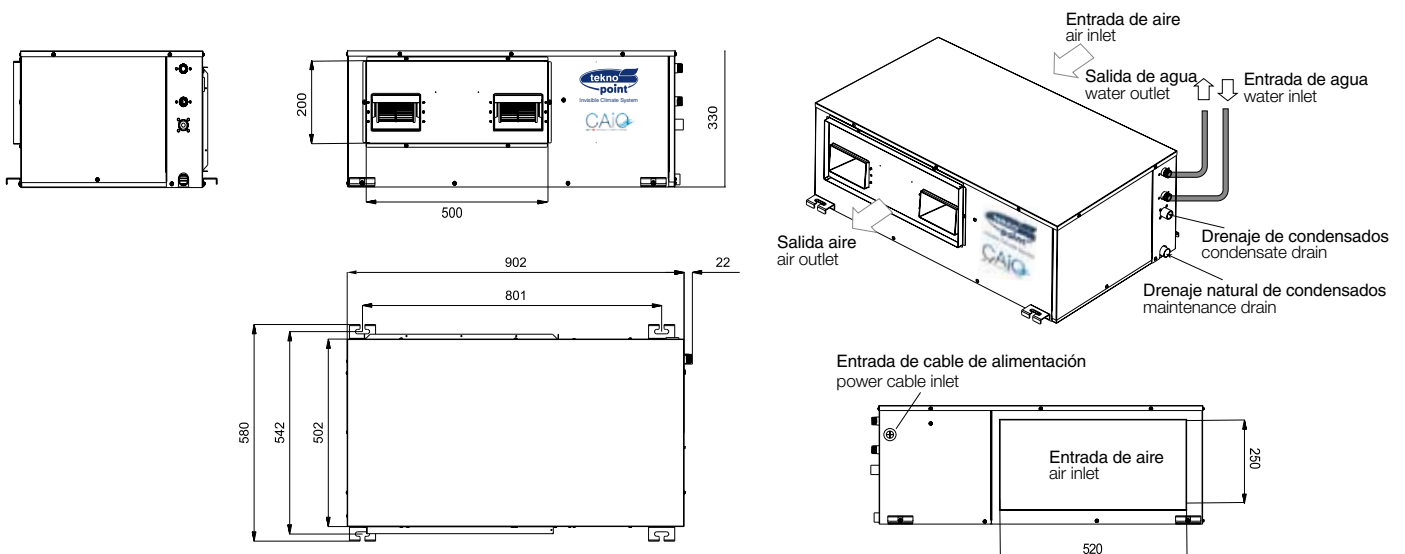

Dimensiones CAIO (mm) - Dimensions of CAIO (mm)

Conexiones CAIO - Connections of CAIO



Las unidades monobloque canalizables se caracterizan por una extrema facilidad y versatilidad de instalación. Combinan las ventajas de la compacidad, la silenciosidad y la facilidad de instalación con el reconocido confort tanto en verano como en invierno, sin necesidad de unidad exterior.

Ducted monoblock or direct expulsion, water cooled
The ductable packaged units are characterised by extreme ease and versatility of installation. This fully internal solution combines the advantages of compactness, quietness and comfort in both summer and winter.



MONOBLOQUE CANALIZABLE CONDENSADO POR AGUA
DUCTABLE WATER-COOLED MONOBLOC



CAI-12C SOLO FREDDO
CAI-12H POMPA DI CALORE
Monobloque canalizable
Ductable monobloc



CAI-18C SOLO FREDDO
CAI-18H POMPA DI CALORE
Monobloque canalizable
Ductable monobloc

CAIO VANTAJAS

El climatizador compacto condensado por agua:

- Sin unidad exterior
- Sin perforaciones en la pared exterior
- Sin conexión frigorífica

ADVANTAGES CAIO

The water-cooled packaged air conditioner:

- No outdoor unit
- No holes in the outer wall
- No refrigerant connection



FIL-CAI
Mando cableado de serie
Wire controller standard



TELC2 (optional)
Mando a distancia con función IFeel
Remote control with IFeel function

Solo frío - Cooling only

CAI-12C

CAI-18C

Bomba de calor - Heat Pump

CAI-12C

CAI-18

CAIO MONOBLOQUE CANALIZABLE AGUA-AIRE WATER-TO-AIR DUCTABLE MONOBLOCK



LOS INVISIBLES
THE INVISIBLES



El monobloque CAIO, disponible en dos tamaños de 3,5 y 5 kW, es la solución más pequeña y rápida de refrigeración/calefacción en los centros históricos. La extrema facilidad de instalación se ve reforzada por la posibilidad de elegir entre los kits de fijación y de ventilación suministrados.



The CAIO monobloc, available in the two sizes of 3.5 and 5 kW, is the smallest and fastest cooling / heating solution in historic centers. The extreme ease of installation is emphasized by the possibility of choosing the fixing kits and aeration kits provided.

CAIO Monobloque condensado por agua - Water-cooled monoblock					
Solo frío - Only Cooling			Cod.	CAI-12C	CAI-18C
Bomba de calor - Heat Pump			Cod.	CAI-12H	CAI-18H
Alimentación - Power Supply			V-Hz-Ph	230-50-1	230-50-1
Protección contra sobrecorriente - Max Overcurrent Protection			A	16	25
Selección de cables de alimentación - Power cable cross-sectional area			mm ²	1,5	2,5
Refrigeración Cooling	Potencia Capacity	Nominal	W/BTU	3500/12000	5200/17742
		Min/Max	W	1500/4100	2100/5900
	Consumo eléctrico Max power absorbtion	Nominal	W	800	1260
		Min/Max	W	280/1310	360/1260
EER		W/W		4,37	4,12
Clase energética - Energy class			-	A++	A++
Calefacción Heating	Potencia Capacity	Nominal	W/BTU	3500/12000	5200/17742
		Min/Max	W	1500/3900	2550/5950
	Consumo eléctrico Max power absorbtion	Nominal	W	940	1380
		Min/Max	W	290/1220	350/1820
COP		W/W		3,72	3,78
Clase energética - Energy class			-	A+	A+
Presión sonora - Sound level			dB(A)	42	45
Potencia sonora - Sound power			dB(A)	52	55
Método de regulación - Throttling method			-	capilar - capillary	EEV
Dimensiones - Dimensions (LxPxH)			mm	900 x 500 x 330	900 x 500 x 330
Peso - Weight			Kg	41	49
Compresor - Compressor			Marca	GMCC	GMCC
Refrigerante Refrigerant	Tipo - Type		-	R32	R32
	Precarga - Precharge		Kg	0,75	0,90
Presión estática disponible - ESP			Pa	0-40	0-100
Caudal de aire - Air flow			m ³ /h	600	900
Conexiones de agua - Water connections			inch	1/2"	1/2"
Presión óptima del agua de entrada - Optimal inlet water pressure			bar	1,5 - 2,0	1,5 - 2,0
Consumo de agua - Use of water	Refrigeración - Cooling		m ³ /h	0,14	0,18
	Calefacción - Heating		m ³ /h	0,17	0,30
Temperatura ajustable Set temperature range	Unidad interior - Indoor Unit		°C	+16~+31	+16~+31
Límites de funcionamiento Operating limits	Agua de entrada (refrig/calef) Inlet Water (heat/cool)		°C	+12 / +25	+12 / +25
Brida de retorno - Air inlet flange (LxH)			mm	522 x 255	522 x 255
Brida de impulsión - Air supply flange (LxH)			mm	500 x 200	500 x 200
Bomba de drenaje de condensados estándar Standard drain pump	Empuje vertical - Vertical thrust		m	0,8	0,8
	Diámetro - Diameter		mm	26	26
Contacto seco para kit multizona - Dry contact for multi-zone control system kit			-	Estándar - standard	Estándar - standard

N.B.: La normativa no exige SEER y SCOP para las unidades agua-aire | The regulations do not require SEER and SCOP for water-to-air units.

Condiciones de prueba Refrigeración: agua entrada/salida 15/40 °C
Calefacción: agua entrada/salida 15/4 °C.
Condiciones de prueba unidad interior Refrigeración: unidad interior 27 °C B.S. Calefacción: unidad interior 20 °C B.S.

Test conditions Cooling: water inlet/outlet 15/40°C
Heating: water inlet/outlet 15/4°C
Indoor unit test conditions Cooling: indoor unit 27°C D.B.
Heating: indoor unit 20°C D.B.

KIT DE CONDUCTOS CAIO - CAIO DUCTING KIT

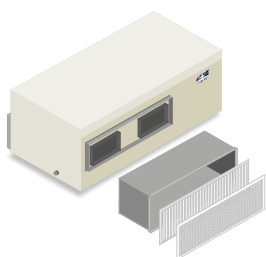

Emisión directa
Direct emission

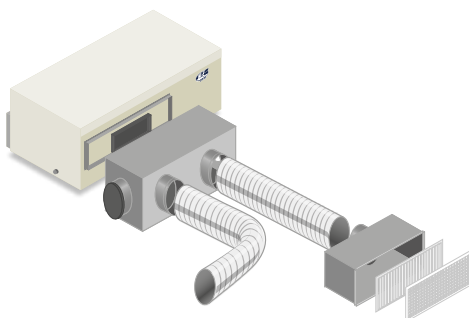

Canalizable hacia 2-3-4 rejillas de impulsión
Ductabled to 2-3-4 outlets

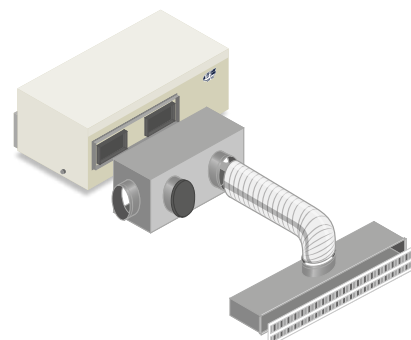

Canalizable hacia difusores lineales
Ductabled to linear diffusers

KIT DE VENTILACIÓN OPCIONAL CON CONDUCTO RECTANGULAR OPTIONAL VENTILATION KIT WITH RECTANGULAR DUCT

De 1 a 4 habitaciones
From 1 to 4 rooms



Código del kit Kit code	Mod.	Nº de zonas	Rejilla de retorno Return grille	Plenum de impulsión Delivery plenum		N.º de abrazaderas No. clamps	Tubo flexible Flexible duct	Caja de calma Plenum box		Compuertas manuales Manual dampers			Rejilla de impulsión Supply grilles		
				plm-cai-01 cm 50x20	plm-cai-04 cm50x20/4/160			pl-301515b	pl-401515b	serman-3015b	serman-4015b	serman-5020b	man-3015b	man-4015b	man-5020b
KIT AIRCAIO12/1	CAI-12	1	RIPF-5225	1		0	flex160 mt 10	0	0			1	1		1
KIT AIRCAIO12/2	CAI-12	2			1	4		2		2			2		
KIT AIRCAIO18/1	CAI-18	1		1		0		0				1	1		1
KIT AIRCAIO18/2	CAI-18	2			1	4		2		2				2	
KIT AIRCAIO18/3	CAI-18	3			1	6		2	1	2	1		2	1	
KIT AIRCAIO18/4	CAI-18	4			1	8		4		4			4		

KIT DE VENTILACIÓN OPCIONAL CON DIFUSOR LINEAL OPTIONAL VENTILATION KIT WITH LINEAR DIFFUSER

De 1 a 4 habitaciones
From 1 to 4 rooms



Código del kit Kit code	Mod.	Nº de zonas	Rejilla de retorno Return grille	Plenum de impulsión Delivery plenum		N.º de abrazaderas No. clamps	Tubo flexible Flexible duct	Caja de calma Plenum box	Difusores lineales Linear diffusers
				plm-cai-01 cm 50x20	plm-cai-04 cm50x20/4/160				
KITLINCAIO12/1	CAI12	1	RIPF-5225	1		4	flex160 mt 10	TPPDL3-2/1	TPDL2-1000
KITLINCAIO12/2	CAI12	2			1	4		2	2
KITLINCAIO18/2	CAI18	2			1	4		2	2
KITLINCAIO18/3	CAI18	3			1	6		3	3
KITLINCAIO18/4	CAI18	4			1	8		4	4

KIT DE CONDUCTOS CAIO - CAIO DUCTING KIT

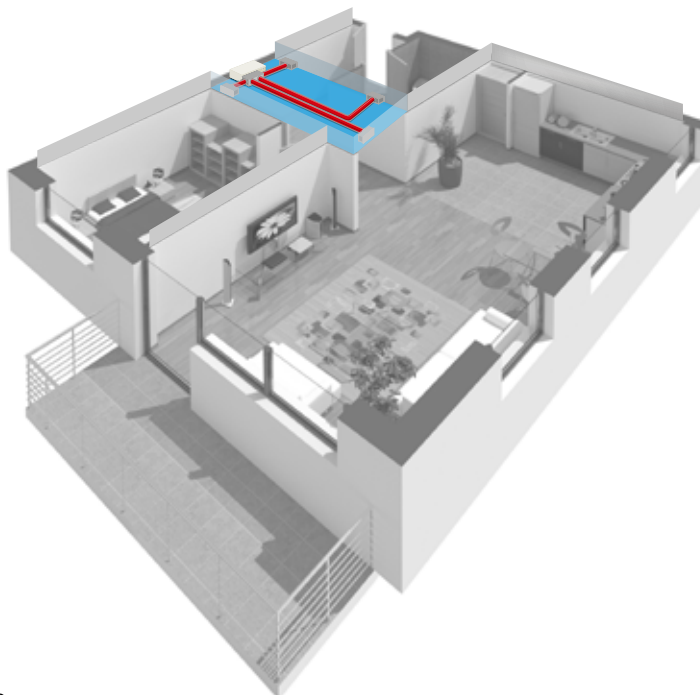

ACCESORIOS - ACCESSORIES

	Código - Code	Descripción - Description	Modelo Model
	PLM CAI 01	Plenum CAIO 1 Para fijar la rejilla de impulsión CAIO Plenum 1 To fix the delivery grille	CAIO 12 CAIO 18
	PLM CAI 04	Plenum CAIO 4 Para la distribución del aire de impulsión hasta 4 zonas CAIO Plenum 4 For distribution of outgoing air up to 4 zones	CAIO 12 CAIO 18
	KIT FIX CAIO	Kit de fijación al techo compuesto por: 4 varillas roscadas CMS 100 M8, 4 tuercas galvanizadas, 4 tuercas autoblocantes 8 arandelas galvanizadas, 4 juntas circulares antivibración, 4 anclajes de malla para anclaje químico, 1 cartucho de resina química Multicomponent. Ceiling fastening kit consisting of: 4 cms 100 M8 threaded rods - 4 galvanized nuts - 4 self-locking nuts - 8 galvanized washers, 4 anti-vibration circular gaskets, 4 mesh anchors x chemical anchor, 1 package Multicomponent chemical anchor.	CAIO 12 CAIO 18
	KIT AWHAM	Kit anti golpe de ariete. Reduce los picos de presión en el circuito de suministro de agua que podrían provocar ruidos y vibraciones no deseados. Anti water hammer kit. Reduces pressure surges in the water supply circuit that could cause unwanted noise and vibration	IDRA (todos los modelos - all models) + CAIO
	RID-PR	Reductor de presión con manómetro integrado. Pressure reducer with integrated pressure gauge.	IDRA (todos los modelos - all models) + CAIO
	VALSIC	Válvula de seguridad de agua normalmente cerrada. La válvula se cierra en caso de fallo de corriente, apagado de la unidad o error de la unidad. Normally closed safety water valve. The valve closes in case of power failure, unit shutdown and unit in error.	IDRA (todos los modelos - all models) + CAIO

Kit de regulación multizona disponible en la sección "Accesorios para unidades de conductos."
Multi-zone regulation kit available in the "Duct units accessories" section.



El aire acondicionado monobloque iQ sin unidad exterior es una solución ideal para enfriar, deshumidificar y calentar con bomba de calor. El evaporador y la unidad condensadora están combinados en un solo bloque de dimensiones muy reducidas.



The iQ monoblock air conditioner without external unit is an ideal solution for cooling, dehumidifying and heating with a heat pump. The evaporator and condensing unit are combined in a single block with very small dimensions.



MONOBLOQUE FIJO AIRE-AIRE DE DOBLE CONDUCTO
FIXED AIR-AIR DOUBLE DUCTED MONOBLOC



iQ
 De doble conducto, montado en pared
 Double duct wall mounted

VENTAJAS

El aire acondicionado y bomba de calor de doble conducto más potente:

- Sin unidad exterior
- Sin conexión de refrigerante

ADVANTAGES

The most powerful double duct air conditioner and heat pump:

- No external unit
- No refrigerant connection



Mando a distancia incluido
 Standard Remote Control

Bomba de calor - Heat Pump

IQ-32

iQ

MONOBLOQUE FIJO AIRE-AIRE DE DOBLE CONDUCTO

FIXED AIR-AIR DOUBLE DUCTED MONOBLOC



Unidad monobloque en bomba de calor On/Off - Monoblock heat pump On/Off				
Código - Code				IQ-32
Alimentación - Power Supply		V-Hz-Ph		230-50-1
Refrigeración Cooling	Potencia Capacity	Nominal	W/BTU	3350/11500
		Max	W	3520
	Consumo eléctrico Max power absorbtion	Nominal	W	1290
		EER	W/W	2,60
Clase energética - Energy class				A
Calefacción Heating	Potencia Capacity	Nominal	W/BTU	3520/12000
		Max	W	4020*
	Consumo eléctrico Max power absorbtion	Nominal	W	1210
		Corriente absorbida - Electrical current	A	5,80
	COP	W/W	3,10	
Clase energética - Energy class				A
Resistencia eléctrica auxiliar - Auxiliary electric heater*		W		500
Presión sonora - Sound level		dB(A)		In 49-50 / Out 52-55
Potencia sonora - Sound power		dB(A)		60 In - 70 Out
Caudal de aire - Air flow		m³/h		low 400 - mid 450 - hi 500
Caudal de aire exterior - External Air flow		m³/h		450 - 600
Método de regulación - Throttling method				Capillar - Capillary
Dimensiones - Dimensions (LxPxH)		mm		1000 x 580 x 245
Peso - Weight		Kg		45
Refrigerante Refrigerant	Tipo - Type		-	
	Precarga - Precharge		Kg	
Diámetro de las tuberías de aire para el intercambio térmico Duct diameter, inlet and exhaust air		mm		Ø 162 (2 for)
Nebulización de condensación verano/invierno Summer/winter condensation misting				no
Instalación - Installation				de suelo floor standing
Límites de funcionamiento (refr/cal) - Operating limits (cool/heat)		C°		10-52/-5-24

CONDICIONES DE PRUEBA: Refrigeración: Int. 27 °C B.S. - Ext. 35 °C B.S. / 24 °C B.H. Calefacción: Int. 20 °C B.S. - Ext. 7 °C B.S. / 6 °C B.H

TEST CONDITIONS: Cooling: Int. 27°C D.B. - East 35°C B.S. / 24°C W.B. Heating: Int. 20°C D.B. - Ext 7°C B.S. / 6°C W.B.



Controles a bordo de la máquina (en iQ-32)
Control board

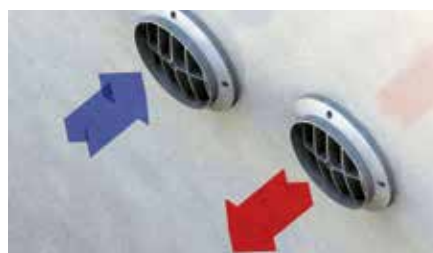

Rejillas flexibles de 160 mm incluidas
Flexible standard grilles





Rejillas ocultables opcionales
Optional tilting grilles

ACCESORIOS OPCIONALES - OPTIONAL ACCESSORIES

	Código - Code	Descripción - Description
	GR-IQ	Rejilla oculta Tilting grid
	ACC-0002-1	El sistema de nebulización puede evitar la conexión al desagüe de agua. En modo calefacción, está disponible solo para temperaturas exteriores superiores a 0 °C. The spray system can avoid the water drainage connection. In heating mode, this is available only when the outdoor temperature is above 0°C.



 Monobloque de doble conducto super slim equipado con compresor On/Off de alta eficiencia que combina un funcionamiento económico con el nivel sonoro más bajo de su categoría y una alta eficiencia en calefacción gracias a las baterías PTC estándar. Además, permite la aportación de aire fresco gracias a su compuerta manual.

 Super slim double duct monoblock equipped with a high-efficiency on-off compressor that combines economical operation, with the lowest noise in its field, with high efficiency in heating thanks to standard PTC coils. It also allows a fresh air supply thanks to its manual damper.

iSTYLE

MONOBLOQUE DE DOBLE CONDUCTO SUPER SLIM
DOUBLE DUCT MONOBLOCK SUPER SLIM



iSTYLE
Entrada de aire fresco gracias a su compuerta manual
Fresh air supply thanks to its manual damper.



Orificio dedicado a la renovación del aire ambiente (opcional)
Dedicated opening for indoor air renewal (optional)



Mando a distancia incluido
Standard Remote Control

Bombas de calor - Heat Pump

iSTYLE



iSTYLE

MONOBLOQUE AIRE-AIRE

DOUBLE DUCT MONOBLOCK



Unidad monobloque en bomba de calor On/Off - Monoblock heat pump On/Off				
Código - Code		-	iSTYLE	
Alimentación - Power Supply		V-Hz-Ph	230-50-1	
Refrigeración Cooling	Potencia Capacity	Nominal	W/BTU	2100/9000
	Consumo eléctrico Max power absorbtion	Nominal	W	981
	EER		W/W	2,67
Clase energética - Energy class		-	A	
Calefacción Heating	Potencia Capacity	Nominal	W/BTU	2100/9500
	Consumo eléctrico Max power absorbtion	Nominal	W	880
	COP		W/W	3,10
Clase energética - Energy class		-	A	
Resistencia eléctrica auxiliar - Auxiliary electric heater*		W	1500	
Presión sonora - Sound level		dB(A)	48 In - 55 Out	
Potencia sonora - Sound power		dB(A)	59 In - 66 Out	
Potencia térmica del circuito hidráulico - Hot water heating capacity		W	low 215 - mid 280 - hi 340	
Caudal de aire - Air flow		m³/h	350 - 550	
Dimensiones - Dimensions (LxPxH)		mm	1000 x 160 x 550	
Peso - Weight		Kg	45	
Refrigerante Refrigerant	Tipo - Type	-	R32	
	Precarga - Precharge	Kg	0,4	
Diámetro de las tuberías de aire para el intercambio térmico Duct diameter, inlet and exhaust air		mm	Ø 162 (2 fori)	
Capacidad de deshumidificación - Dehumidification capacity		L/24h	16,3	
Nebulización de condensación verano/invierno Summer/winter condensation misting		-	Kit opcional - Optional kits	
Instalación - Installation		-	de suelo floor standing	
Límites de funcionamiento (refr/cal) Operating limits (cool/heat)		°C	10-52/-5-24	

	Código - Code	Descripción - Description
	GR-IQ	Rejilla oculta Tilting grid
	ACC-0002-1	El sistema de nebulización puede evitar la conexión al desagüe de agua. En modo calefacción, está disponible solo para temperaturas exteriores superiores a 0 °C. The spray system can avoid the water drainage connection. In heating mode, this is available only when the outdoor temperature is above 0°C.

NEW



El climatizador sin unidad exterior Moka representa la elección perfecta para quienes desean combinar altas prestaciones con una estética esencial. Diseñado para una instalación sencilla y rápida, elimina el volumen de la unidad exterior ofreciendo una solución discreta e integrada en los espacios. La tecnología inverter garantiza un funcionamiento silencioso y eficiente, proporcionando confort constante en cualquier estación y un impacto ambiental reducido, ideal para cualquier entorno residencial o profesional.

The Moka air conditioner without an outdoor unit is the ideal choice for those seeking high performance combined with refined design. Engineered for quick and easy installation, it eliminates the need for an external unit, offering a discreet solution that integrates seamlessly into any space. Its inverter technology ensures quiet and efficient operation, delivering year-round comfort with reduced environmental impact-perfect for both residential and professional environments.

MOKA

MONOBLOQUE AIRE-AIRE DE DOBLE CONDUCTO CON WI-FI
 DOUBLE DUCT AIR-TO-AIR MONOBLOC UNIT WITH WI-FI

R290



MOKA
 Tecnología inverter en las versiones MOKA-10 y MOKA-12
 Inverter technology in MOKA-10 and MOKA-12 versions



Descargando la App Smart Life (iOS y Android) podrás controlar tu equipo mediante conexión con tu red Wi-Fi doméstica.
 By downloading the Smart Life app (iOS and Android), you can control your unit through a connection to your home Wi-Fi network.



Mando a distancia incluido
 Standard Remote Control

Solo frío - Cooling only

MOKA-08

Bombas de calor - Heat Pump

MOKA-10

MOKA-12

MOKA

MONOBLOQUE AIRE-AIRE DE DOBLE CONDUCTO

DOUBLE DUCT MONOBLOC



Unità monoblocco doppio tubo Inverter - Inverter double-tube monobloc unit						
Código - Code		-		MOKA-08	MOKA-10	MOKA-12
Alimentación - Power Supply		V-Hz-Ph		230-50-1	230-50-1	230-50-1
Refrigeración Cooling	Potencia Capacity	Nominal	W/BTU	2350/8000	2930/10000	3500/12000
	Consumo eléctrico Max power absorbtion	Nominal	W	900	1120	1340
	EER		W/W	2,6	2,6	2,6
	Clase energética - Energy class		-	A	A	A
Calefacción Heating	Potencia Capacity	Nominal	W/BTU	-	2630/9000	2930/10000
	Consumo eléctrico Max power absorbtion	Nominal	W	-	730	815
	COP		W/W	-	3,6	3,6
	Clase energética - Energy class		-	-	A+	A+
Resistencia eléctrica auxiliar - Auxiliary electric heater*			W	-	-	800
Presión sonora - Sound level			dB(A)	27 In - 49 Out	28 In - 47 Out	29 In - 49 Out
Potencia sonora - Sound power			dB(A)	38 In - 60 Out	39 In - 58 Out	40 In - 60 Out
Caudal de aire - Air flow			m³/h	500	520	520
Dimensiones - Dimensions (LxPxH)			mm	1000x585x205	1000x585x205	1000x585x205
Peso - Weight			Kg	44,5	42,5	45
Refrigerante Refrigerant	Tipo - Type		-	R290	R290	R290
	Precarga - Precharge		Kg	0,28	0,29	0,29
Diámetro de las tuberías de aire para el intercambio térmico Duct diameter, inlet and exhaust air			mm	Ø 180 (2 fori)	Ø 180 (2 fori)	Ø 180 (2 fori)
Capacidad de deshumidificación - Dehumidification capacity			L/h	0,8	1,0	1,2
Nebulización de condensación Condensation misting	Estival - Summer		-	Sí-yes	Sí-yes	Sí-yes
	Invernal - Winter		-	-	Kit opcional - Optional kits	Kit opcional - Optional kits
Límites de funcionamiento (refr/cal) Operating limits (cool/heat)			°C	10~52/-5~24	10~52/-5~24	10~52/-5~24



Controlador con pantalla táctil integrado en la unidad
On-board touchscreen controller



Rejillas exteriores plegables con cadena para
instalación desde el interior
Foldable external grilles with safety
chain for indoor installation

Codice - Code	Descrizione - Description
 <p>ACC-0002-1</p>	<p>El sistema de nebulización puede evitar la conexión al desagüe de agua. En modo calefacción, está disponible solo para temperaturas exteriores superiores a 0 °C.</p> <p>The spray system can avoid the water drainage connection. In heating mode, this is available only when the outdoor temperature is above 0°C.</p>



El nuevo modelo ATHENA-C es la solución más adecuada para los centros históricos, edificios de valor arquitectónico y en cualquier lugar donde sea esencial preservar la estética arquitectónica de la estructura.

ATHENA-C ha sido desarrollado para instalarse completamente en el interior del edificio; es necesaria una conexión directa al exterior a través de un orificio en la pared perimetral para la toma y la expulsión de aire.



The new ATHENA-C model is the most suitable solution for historical centers, buildings of architectural value, and anywhere it is essential to preserve the architectural aesthetics of the structure.

ATHENA-C has been developed to be installed entirely inside the building; it is necessary a direct connection to the outside through a hole in the perimeter wall for air intake and exhaust.

ATHENA-C

BOMBA DE CALOR MONOBLOQUE AIRE-AGUA INTERIOR INTERNAL AIR-TO-WATER MONOBLOC HEAT PUMP



ATHENA-C
Bomba de calor aire-agua
Air-to-water heat pump



Modalidades de instalación

Athena-C está preparada tanto para la instalación vertical como horizontal. El módulo de agua caliente sanitaria (ACS) puede colocarse encima del módulo de la bomba de calor o en el lado derecho. Los tubos de conexión ya están previstos en ambos módulos para ambas soluciones.

Installation mode

Athena-C is prepared for both vertical and horizontal installation. The domestic hot water (DHW) module can be placed either above the heat pump module or on the right side. Connection pipes are already provided in both modules for both solutions.



Integración con el sistema ERA: los datos técnicos y las descripciones están disponibles en la sección "Automatización de edificios" del catálogo.

Integration with ERA system: technical data and descriptions are available in the "Building Automation" section of the catalogue.

ATHENA-C BOMBA DE CALOR MONOBLOQUE AIRE-AGUA INTERIOR

INTERNAL AIR-TO-WATER MONOBLOC HEAT PUMP



LOS INVISIBLES
THE INVISIBLES

Athena-C Bomba de calor monobloque aire-agua interior - Air water heat pump fully internal							
Código - Set code		-	A-0532-C200	A-0732-C200	A-0932-C200		
Módulo BDC - HP unit		-	A-0532-C	A-0732-C	A-0932-C		
Módulo ACS - DHW unit		-	A-0532-C DHW	A-0732-C DHW	A-0932-C DHW		
Alimentación - Power Supply		V-Hz-Ph	230-50-1	230-50-1	230-50-1		
Protección contra sobrecorriente - Max Overcurrent Protection			25	25	25		
Sección de los cables de alimentación - Power cable cross-sectional area		mm ²	2,5	2,5	4		
Refrigeración Cooling	A35/W7	Potencia - Capacity	Nom. (min/max)	kW	3.21 (1.65-4.28)	4.35 (2.75-6.01)	6.12 (3.58-7.45)
		P. abs. - Power	Nom. (min/max)	kW	1.26 (0.68-2.01)	1.71 (1.07-2.38)	2.30 (1.37-3.21)
		EER	Nom.	W/W	2.55 (2.41-3.05)	2.54 (2.38-3.06)	2.66 (2.45-3.08)
	A35/W18	Potencia - Capacity	Nom. (min/max)	kW	4.81 (1.85-5.56)	6.79 (2.93-7.22)	8.79 (3.71-9.35)
		P. abs. - Power	Nom. (min/max)	kW	1.15 (0.62-2.03)	1.65 (1.05-2.12)	2.14 (1.32-3.15)
		EER	Nom.	W/W	4.18 (2.49-5.02)	4.12 (2.48-5.11)	4.11 (2.52-5.12)
Calefacción Heating	A7/W35	Potencia - Capacity	Nom. (min/max)	kW	5.06 (2.37-6.82)	6.16 (3.26-7.43)	8.58 (4.50-10.26)
		P. abs. - Power	Nom. (min/max)	kW	1.27 (0.52-1.68)	1.58 (0.82-1.91)	2.11 (1.07-2.50)
		COP	Nom.	W/W	3.98 (3.30-5.23)	3.90 (3.30-5.21)	4.07 (3.30-5.23)
	A7/W55	Potencia - Capacity	Nom. (min/max)	kW	4,12 (2,64-4,34)	5,02 (3,21-5,28)	6,99 (4,47-7,36)
		P. abs. - Power	Nom. (min/max)	kW	1,45 (1,03-1,60)	1,80 (1,27-1,99)	2,39 (1,70-2,66)
		COP	Nom.	W/W	2,85 (2,57- 2,71)	2,79 (2,52-2,65)	2,92 (2,63-2,77)
	A2/W35	Potencia - Capacity	Nom. (min/max)	kW	4.52 (2.92-6.42)	5.76 (2.92-7.32)	7.89 (3.74-9.22)
		P. abs. - Power	Nom. (min/max)	kW	1.19 (0.52-1.66)	1.52 (0.82-1.86)	2.05 (1.02-2.45)
		COP	Nom.	W/W	3.80 (2.30-4.60)	3.79 (2.30-4.21)	3.85 (2.40-4.20)
	A-7/W35	Potencia - Capacity	Nom. (min/max)	kW	3.72 (2.22-4.60)	5.03 (2.52-5.86)	6.33 (3.28-7.71)
		P. abs. - Power	Nom. (min/max)	kW	1.15(0.48-1.62)	1.57 (0.79-1.78)	1.95 (0.99-2.48)
		COP	Nom.	W/W	3.23 (2.56-3.84)	3.20 (2.56-3.64)	3.25 (2.64-3.96)
	A-7/W55	Potencia - Capacity	Nom. (min/max)	kW	3,03 (1,94-3,19)	4,10 (2,62-4,31)	5,16 (3,30-5,43)
		P. abs. - Power	Nom. (min/max)	kW	1,31 (0,93-1,45)	1,79 (1,27-1,98)	2,21 (1,57-2,46)
		COP	Nom.	W/W	2,31 (2,09-2,20)	2,29 (2,07-2,18)	2,33 (2,10-2,21)
	A-15/W35	Potencia - Capacity	Nom. (min/max)	kW	3,36 (2,15-3,54)	4,21 (2,70-4,43)	5,30 (3,39-5,57)
		P. abs. - Power	Nom. (min/max)	kW	1,24 (0,88-1,38)	1,49 (1,06-1,65)	1,84 (1,31-2,04)
		COP	Nom.	W/W	2,70 (2,44-2,57)	2,83 (2,55-2,69)	2,87 (2,59-2,73)
	A-15/W55	Potencia - Capacity	Nom. (min/max)	kW	2,45 (1,57-2,58)	3,43 (2,19-3,61)	4,32 (2,76-4,54)
		P. abs. - Power	Nom. (min/max)	kW	1,34 (0,95-1,48)	1,70 (1,20-1,87)	2,10 (1,49-2,33)
		COP	Nom.	W/W	1,83 (1,66-1,74)	2,02 (1,83-1,93)	2,06 (1,86-1,95)
	Clase energética - Energy class (W35°/W55°)		-	A+++/A++	A+++/A++	A+++/A++	
	Potencia sonora - Sound power		dB(A)	61	61	61	
	Método de regulación - Throttling method		-	EEV	EEV	EEV	
Dimensiones módulo BDC - HP module dimensions (LxPxH)		mm	870 x 705,6 x 1178,5	870 x 705,6 x 1178,5	870 x 705,6 x 1178,5		
Dimensiones módulo ACS - DHW module dimensions (LxPxH)		mm	870 x 705,6 x 1178,5	870 x 705,6 x 1178,5	870 x 705,6 x 1178,5		
Peso - Weight		Kg	118	127	136		
Compresor - Compressor		-	MITSUBISHI	MITSUBISHI	MITSUBISHI		
Tipo de compresor - Type of compressor		-	DC inverter	DC inverter	DC inverter		
Ventilador - Fan		-	1 AC	1 AC	1 AC		
Desescarche - Defrosting		-	Auto-defrosting	Auto-defrosting	Auto-defrosting		
Refrigerante		Tipo - Type	R32	R32	R32		
Refrigerant		Precarga - Precharge	gr	650	700	1500	
Intercambiador de calor - Heat exchanger		-	Intercambiador de placas - Brazed plate heat exchanger (SWEP)				
Bomba de circulación - Circulation pump		-	SHIMGE APM25-12-180				
Conexiones de agua - Water connections		inch	1"	1"	1"		
Flujostato - Water flow swich		-	SIKA	SIKA	SIKA		
Caudal de agua nominal - Nominal water flow rates		m ³ /h	1,1	1,4	1,8		
Temp. mínima del agua de refrigeración - Min cooling water temp.		°C	8	8	8		
Temperatura máxima AT - Maximum HT temperature		°C	60	60	60		
Temperatura máxima de ACS - Maximum DHW temperature		°C	55	55	55		
Grado de protección - Degree of protection		-	IPX4	IPX4	IPX4		
Temperatura ajustable - Set temperature range		°C	-20-+43	-20-+43	-20-+43		
Eficiencia energética estacional		ETAS W35°/W55°	-	177.0% / 134.5%	177.0% / 134.5%		
Seasonal energy efficiency		ACS - DHW W55°	-	130%	130%		
Resistencia eléctrica módulo BDC - HP unit electric heater		kW	1,5	1,5	1,5		
Resistencia eléctrica módulo ACS - DHW unit electric heater		kW	1,5	1,5	1,5		
Volumen del depósito de ACS - DHW tank volume		L	200	200	200		
Volumen del depósito de inercia - Buffer tank volume		L	10	10	10		
Tamaño de la rejilla exterior - External grid size		mm	700x900	700x900	700x900		
System expansion vassel - System expansion vassel		L	6	6	6		
Vaso de expansión de ACS - DHW expansion vassel		L	12	12	12		

CONDICIONES DE PRUEBA:

- A7/W35: temp. aire exterior 7 °C B.S./6 °C B.H., temp. agua entrada/salida 30 °C/35 °C
- A2/W35: temp. aire exterior 2 °C B.S./1 °C B.H., temp. agua entrada/salida 30 °C/35 °C
- A-7/W35: temp. aire exterior -7 °C B.S./-8 °C B.H., temp. agua entrada/salida 30 °C/35 °C
- A35/W7: temp. aire exterior 35 °C, temp. agua entrada/salida 12 °C/7 °C

TEST CONDITION:

- A7/W35: outdoor air temp. 7°C D.B./6°C W.B., water inlet/outlet temp. 30°C/35°C
- A2/W35: outdoor air temp. 2°C D.B./1°C W.B., water inlet/outlet temp. 30°C/35°C
- A-7/W35: outdoor air temp. -7°C D.B./-8°C W.B., water inlet/outlet temp. 30°C/35°C
- A35/W7: outdoor air temp. 35°C, water inlet/outlet temp. 12°C/7°C

ACERCA DE ATHENA-C ABOUT ATHENA-C

¿POR QUÉ ELEGIR ATHENA-C? WHY CHOOSE ATHENA-C?

Respeto por la decoración arquitectónica

Ningún elemento exterior en edificios del centro histórico y en construcciones de nueva concepción. Un nuevo estilo arquitectónico se está difundiendo en el diseño de edificios. Compacidad y silencio aplicados a las nuevas energías alternativas.

Respect for architectural decorum

No outdoor elements on historical and new buildings. A new architectural style is spreading in the design of buildings. Compactness and silence applied to new alternative energies.

Ultracompacta y silenciosa dentro de casa

Menos de 0.7 m² para calefacción, refrigeración y ACS, con el mismo nivel de ruido que un refrigerador.

Ultra quiet and compact inside the house

Less than 0,7 m² for heating, cooling and DHW with the noise of a refrigerator.

Sencilla y versátil de instalar

Se adapta a cualquier proyecto, desde la vivienda unifamiliar, hasta el condominio o los complejos residenciales.

Simple and versatile to install

It fits any project, from individual houses and apartment blocks.

Obras de instalación mínimas

Los módulos Athena-C están diseñados para incorporar todos los dispositivos necesarios para la conexión directa al sistema de distribución, tanto de agua sanitaria como de calefacción.

Minimal installation work

Athena-C modules are designed to have all the necessary devices for direct connection to the distribution system, both sanitary water and heating.



Ejemplo de instalación 1
Installation Option 1



Ejemplo de instalación 2
Installation Option 2

SMART LIFE - APP PARA EL CONTROL WI-FI | WI-FI CONTROL APP



La aplicación Smart Life (iOS y Android) ofrece opciones de control de tu equipo a través de la conexión con tu red Wi-Fi doméstica, para una interacción más sencilla y agradable.

The Smart Life app (iOS and Android) provides control options for your device by connecting it to your home Wi-Fi network, for easier and more enjoyable interaction.

¿CUÁLES SON LAS CARACTERÍSTICAS INNOVADORAS DE ATHENA-C? WHAT ARE THE INNOVATIVE FEATURES OF ATHENA-C?

• Modularidad Modularity

Según las necesidades del proyecto, se puede decidir instalar solo el módulo PDC o bien combinarlo también con el módulo ACS.

Depending on the needs of the project, I can decide to install the HP module alone or combine the DHW module with it as well.

• Todo en uno All-in-One

Athena-C sustituye completamente a una pequeña central térmica para abastecer apartamentos de hasta 100-120 m².

Athena-C sustituye completamente a una pequeña central térmica para dar servicio a apartamentos de hasta 100-120 m².

• Plug&Play Plug&Play

El módulo PDC ya cuenta con todos los componentes necesarios para conectarse directamente al sistema de distribución de los terminales hidráulicos.

The PDC module already has all the necessary components to be connected directly to the distribution system to hydronic terminals.

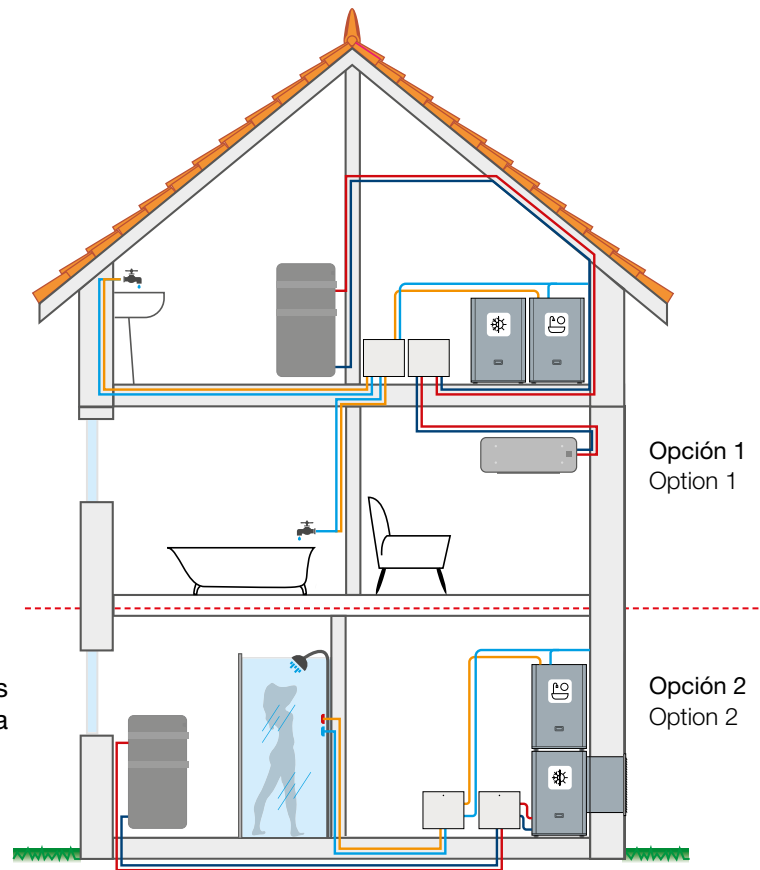

Componentes del módulo ACS

Acumulador 200 L
Ánodo de magnesio
Válvula de retención de entrada de agua
Válvula de seguridad
Carga manual del sistema
Vaso de expansión 12L
Resistencia 1,5 kW

DHW module components

DHW tank 200L
Magnesium rode
Water inlet check valve
Safety valve
Gate valve
Expension vessel 12L
Electric heater 1,5 kW

Componentes del módulo PDC

Circulador Shimgé APM25-12-180
Manómetros lado agua y lado gas
Válvula desviadora de 3 vías
Válvula by-pass
Acumulador técnico 10 L
Válvulas de retención en el retorno
Filtro Y
Vaso de expansión 6 L
Display de control
Resistencia 1,5 kW

HP module components

Shimgé APM25-12-180 circulation pump
Water and gas pressure gauges
3-way valve
By-pass valve
Buffer tank 10L
Water inlet check valves
Y Filter
Expension vessel 6L
Remote control
Electric heater 1,5 kW



VAIA es el nuevo modelo de bomba de calor monobloque aire-agua desarrollado para ser instalado en el interior de la vivienda: la solución perfecta para centros históricos, edificios de valor y en todos aquellos casos en los que sea necesario preservar el decoro arquitectónico del edificio. Es necesario prever la realización de dos conexiones directas con el exterior, mediante orificios en el muro perimetral o en la cubierta para la aspiración y la expulsión del aire, ocultos por una rejilla pintable.



VAIA is the new air-to-water monobloc heat pump model designed to be installed inside the home: the perfect solution for historic centers, prestigious buildings, and any context where preserving the architectural appearance of the building is essential. It requires two direct connections to the outside, created through openings in the perimeter wall or on the roof for air intake and exhaust, both concealed by a paintable grille.

VAIA

BOMBA DE CALOR AIRE-AGUA MONOBLOQUE INTERIOR COMPACTA
 COMPACT INTERNAL AIR-TO-WATER MONOBLOC HEAT PUMP



VAIA
 Bomba de calor aire-agua
 Air-to-water heat pump



Rejilla y plenum bajo pedido
 Grid and plenum available upon request



Control cableado de serie
 Wired controller (standard supply)



Integración con el sistema ERA: los datos técnicos y las descripciones están disponibles en la sección "Automatización de edificios" del catálogo.
 Integration with ERA system: technical data and descriptions are available in the "Building Automation" section of the catalogue.

VAIA

BOMBA DE CALOR AIRE-AGUA MONOBLOQUE INTERIOR COMPACTA

COMPACT INTERNAL AIR-TO-WATER MONOBLOC HEAT PUMP



LOS INVISIBLES
THE INVISIBLES

VAIA Bomba de calor aire-agua monobloque interior - Air water heat pump fully internal						
Código de Set - Set code				-	VAIA-09V1-2	
Alimentación - Power Supply				V-Hz-Ph	230-50-1	
Protección contra sobrecorriente - Max Overcurrent Protection				A	25	
Sección de cables de alimentación - Power cable cross-sectional area				mm ²	4	
Refrigeración	A35/W7	Potencia - Capacity	Nom. (min/max)	kW	6.12 (3.58-7.45)	
		Pot. abs. - Power	Nom. (min/max)	kW	2.30 (1.37-3.21)	
		EER	Nom.	W/W	2.66 (2.45-3.08)	
Refrigeración	A35/W18	Potencia - Capacity	Nom. (min/max)	kW	8.79 (3.71-9.35)	
		Pot. abs. - Power	Nom. (min/max)	kW	2.14 (1.32-3.15)	
		EER	Nom.	W/W	4.11 (2.52-5.12)	
Calefacción	A7/W35	Potencia - Capacity	Nom. (min/max)	kW	8.58 (4.50-10.26)	
		Pot. abs. - Power	Nom. (min/max)	kW	2.11 (1.07-2.50)	
		COP	Nom.	W/W	4.07 (3.30-5.23)	
Calefacción	A7/W55	Potencia - Capacity	Nom. (min/max)	kW	8.12 (3.93-9.56)	
		Pot. abs. - Power	Nom. (min/max)	kW	2.80 (1.36-3.30)	
		COP	Nom.	W/W	2.90 (1.41-3.42)	
Calefacción	A2/W35	Potencia - Capacity	Nom. (min/max)	kW	7.89 (3.74-9.22)	
		Pot. abs. - Power	Nom. (min/max)	kW	2.05 (1.02-2.45)	
		COP	Nom.	W/W	3.85 (2.40-4.20)	
Calefacción	A-7/W35	Potencia - Capacity	Nom. (min/max)	kW	6.33 (3.28-7.71)	
		Pot. abs. - Power	Nom. (min/max)	kW	1.95 (0.99-2.48)	
		COP	Nom.	W/W	3.25 (2.64-3.96)	
Calefacción	A-7/W55	Potencia - Capacity	Nom. (min/max)	kW	6.50 (3.25-7.89)	
		Pot. abs. - Power	Nom. (min/max)	kW	2.71 (1.35-3.27)	
		COP	Nom.	W/W	2.40 (1.20-2.90)	
Calefacción	A-15/W35	Potencia - Capacity	Nom. (min/max)	kW	6.10 (2.92-7.19)	
		Pot. abs. - Power	Nom. (min/max)	kW	2.34 (1.13-2.76)	
		COP	Nom.	W/W	2.61 (1.24-3.06)	
Calefacción	A-15/W55	Potencia - Capacity	Nom. (min/max)	kW	5.50 (2.64-6.49)	
		Pot. abs. - Power	Nom. (min/max)	kW	2.89 (1.38-3.41)	
		COP	Nom.	W/W	1.90 (0.92-2.24)	
Clase energética - Energy class (W35°/W55°)				-	A+++/A+++	
SCOP** (W35°/W55°)				kWh/kWh	4,60/3,61	
Compresor - Compressor				-	1 x Mitsubishi	
Tipo de compresor - Type of compressor				-	DC Inverter	
Ventilador - Fan				-	1 AC	
Refrigerante Refrigerant	Tipo - Type				-	R32
	Precarga - Precharge				gr	1300
Regulación - Regulation				-	EEV	
Desescarche - Defrosting				-	Auto-defrosting	
Intercambiador de calor - Heat exchanger				-	SWEP	
Circulador - Circulation pump				-	SHIMGE APM25-12-180	
Conexiones de agua - Water connections				inch	1"	
Interruptor de flujo - Water flow swich				-	SIKA	
Caudal nominal de agua - Nominal water flow rates				m ³ /h	1,8	
Temp. mínima del agua de refrigeración - Min cooling water temp.				°C	8	
Temperatura máxima AT - Maximum HT temperature				°C	60	
Temperatura máxima ACS - Maximum DHW temperature				°C	55	
Grado de protección - Degree of protection				-	IPX4	
Dimensiones del módulo PDC - HP Dimensions (LxPxH)				mm	790x574x1121	
Peso - Weight				Kg	140	
Límite de funcionamiento de la temperatura exterior - Outdoor Temperature Operating Limit				°C	-20-43	
Eficiencia energética estacional Seasonal energy efficiency*	ETAS W35°/W55°				-	180,9% / 141,6%
	ACS - DHW W55°				-	n.d.

* Los valores de referencia son relativos al clima "Average climate (Tdesign = -10 °C)", conforme a la normativa ErP 2009/125/CE.

* Reference values refer to the "Average climate (Tdesign = -10 °C)" according to the ErP 2009/125/EC regulation.

** calculado según la normativa UNI EN 14825:2022.

** calculated according to UNI EN 14825:2022 standard.

A PROPÓSITO DE VAIA ABOUT VAIA

EJEMPLOS DE INSTALACIÓN INSTALLATION EXAMPLES

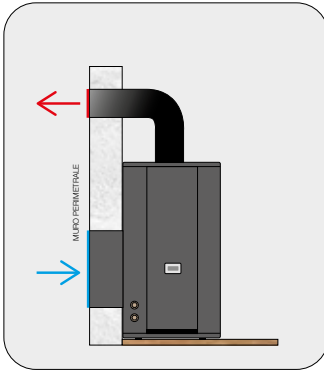

Instalación en pared
Wall installation

Es posible instalar VAIA directamente junto a la pared perimetral, con aspiración y expulsión del aire mediante conductos debidamente aislados que atraviesan la pared del edificio.

It is possible to install VAIA directly against the perimeter wall, with air intake and exhaust through appropriately insulated ducts passing through the building wall.

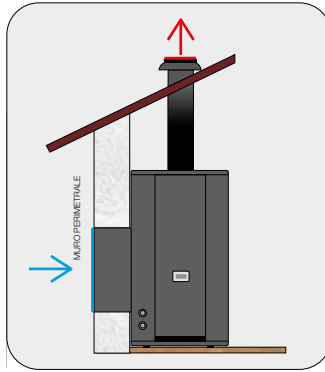

Instalación en pared/techo
Wall/roof installation

Para quienes disponen de un ático, VAIA ofrece una segunda posibilidad: el aire se aspira desde el muro perimetral y se expulsa a través del techo.

For those with an attic space, VAIA offers a second option: air is drawn in through the perimeter wall and expelled through the roof.

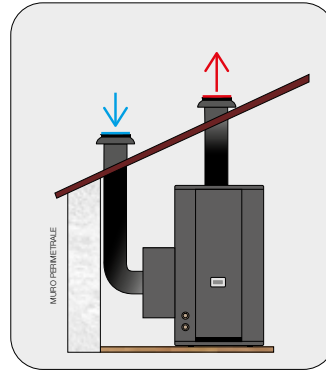

Instalación en techo
Roof installation

La tercera modalidad prevé que tanto la aspiración como la expulsión del aire se realicen directamente a través del techo. También en este caso, la bomba de calor se instala junto a la pared perimetral para ocupar el menor espacio posible.

The third configuration provides for both air intake and air discharge directly through the roof. In this case as well, the heat pump is installed directly against the perimeter wall to minimize the required space.

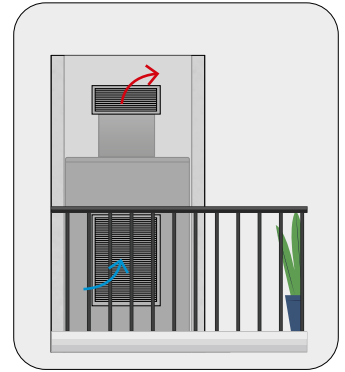

Instalación empotrada exterior
Externally recessed installation

La unidad puede alojarse en un espacio técnico dedicado en el exterior del edificio, permaneciendo no visible y perfectamente integrada en la envolvente arquitectónica.

The unit can be housed in a dedicated technical room outside the building, remaining out of sight and perfectly integrated into the architectural envelope.

SMART LIFE - APP PARA EL CONTROL WI-FI WI-FI CONTROL APP



La aplicación Smart Life (iOS y Android) ofrece opciones de control de tu equipo a través de la conexión con tu red Wi-Fi doméstica, para una interacción más sencilla y agradable.

The Smart Life app (iOS and Android) provides control options for your device by connecting it to your home Wi-Fi network, for easier and more enjoyable interaction.

¿CUÁLES SON LAS CARACTERÍSTICAS INNOVADORAS DE VAIA? WHAT ARE THE INNOVATIVE FEATURES OF VAIA?

• Respeto del decoro arquitectónico Preservation of architectural aesthetics

Ningún elemento exterior en edificios del centro histórico y en construcciones de nueva concepción.

No external elements on buildings in historic city centers or on newly designed constructions.

• Ultra silenciosa y compacta Ultra-quiet and compact

Ocupa menos de 0,5 m².
Compacidad y silenciosidad aplicadas a las nuevas energías alternativas.

Occupies less than 0.5 m².
Compactness and quiet operation applied to next-generation renewable energy solutions.

• Fácil y versátil de instalar Easy and versatile to install

Se adapta a cualquier proyecto, desde la vivienda unifamiliar hasta el apartamento en condominio.

It adapts to any project, from a single-family home to an apartment in a condominium building.

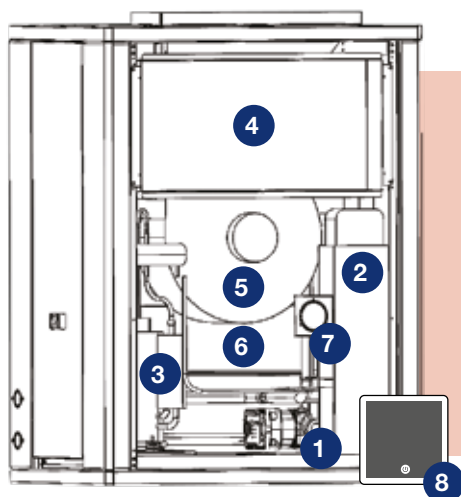
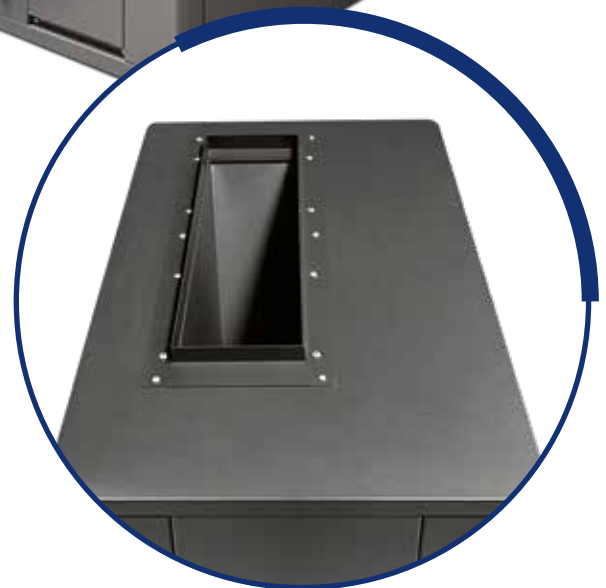

Componentes Vaia

- 1 - Circulador Shimge APM25-12-18
- 2 - Intercambiador de placas
- 3 - Compresor
- 4 - Placas electrónicas
- 5 - Ventilador centrífugo
- 6 - Batería de intercambio
- 7 - Manómetro del lado de gas
- 8 - Pantalla de control

HP module components

- 1- Shimge Circulator APM25-12-18
- 2- Plate Heat Exchanger
- 3- Compressor
- 4- Electronic Boards
- 5- Centrifugal Fan
- 6- Heat Exchange Coil
- 7- Gas-Side Pressure Gauge
- 8- Control Display

NUESTRA GARANTÍA - OUR WARRANTY

¡PROTEGE TU PRODUCTO TEKNO POINT! SECURE YOUR TEKNO POINT PRODUCT!

Tekno Point Italia Srl garantiza sus productos contra todos los defectos de fabricación y de funcionamiento en los equipos vendidos e instalados conforme a la normativa vigente. Para consultar el documento completo de condiciones de venta, condiciones de garantía y extensiones (la garantía se activa tras completar el formulario correspondiente), visita nuestro sitio web: <https://teknopoint.com/es/contactos/warranty-and-extended-warranties>.

Tekno Point Italia Srl guarantees its products against all manufacturing and operational defects on the appliances sold and installed in full compliance with current legal regulations. To find the complete document detailing sales conditions, warranty terms, and extensions (the warranty is activated after filling out the specific form), please visit our website: <https://teknopoint.com/en/contacts/warranty-and-extended-warranties>.



Escanea el código QR
para acceder directamente
a la página del sitio
“Garantías y extensiones”.



Frame the QRcode
to go directly to the site page
“Warranties and Extensions”



Invisible Climate System

TEKNO POINT ITALIA SRL

Via dell'Artigianato, 5 • Marcon (VE) • Italy

Tel. 041 50 20 421 • Fax 041 50 29 514

e-mail info@teknopoint.com

www.teknopoint.com



ESCANEA EL CÓDIGO QR
y descarga el catálogo actualizado

SCAN THE QR-CODE
and download the updated catalogue

Distribuido por - Distributed by

Tekno Point Italia Srl se reserva el derecho de realizar modificaciones en cualquier momento a sus productos, accesorios y datos técnicos con el fin de mejorar su oferta. Este documento no tiene carácter de documentación técnica y podría no estar actualizado con respecto al producto objeto de la oferta comercial. Se recomienda solicitar la documentación técnica oficial del producto que se va a adquirir a Tekno Point Italia.

Tekno Point reserves the right to make changes at any time to its products, accessories, and technical data in order to improve its offerings. The catalogue is not intended as technical documentation and may not be updated with the product being offered commercially. We recommend requesting the official technical documentation of the product being purchased from Tekno Point Italia.